

Citizen CLP and CL-S Range

Command Reference Manual

Version II

Designed for the following printers:

CL-S400DT, CL-S521, CL-S621, CL-S631
CL-S700 series (CL-S700, CL-S700DT, CL-S703, CL-S700R)
CLP 8301

Also compatible with:

CLP 521, CLP 621, CLP 1001, CLP 2001
CLP 6000 series including CLP 6401
CLP 7200e series and CLP 7401
CLP 4081 series, CLP 9000 series

Issue 2.01

Chapter 1

Command Interpreter and Command System

1.1	Outline	1-2
1.2	Outline of Command System	1-2
1.3	Outline of Interpreter	1-4
1.4	Outline of Label Format Data	1-5
1.5	Outline of Label Printing Method	1-7
1.6	Control Code Specification	1-8
	1.6.1 System Level Immediate Execution Commands	1-9
	1.6.2 System Level Occasional Execution Commands	1-14
	1.6.3 Label Format Commands	1-51

1.1 Outline

Generally, when labels of graphics and bar codes are printed by a line printer, print data is converted into bit map data in the computer and transmitted to the printer for printing. In this process the host computer has to generate the bit map data and send it to the printer, this reduces throughput leading to slow printing and host computer operation.

This printer incorporate many functions such as a variety of fonts, bar code generators, and graphic commands along with high speed processing, so high-quality labels can be printed easily at high speeds when simple commands are transmitted from the host computer. The computer processing in generating labels is reduced enabling it to undertake more processing.

1.2 Outline of Command System

Commands for this printer consist of a string of ASCII characters and end with a "CR" (decimal: 13, hex: 0D). Generally, commands are classified into two types, that is, system level commands and label format commands.

System level commands are used in system level operations, including printer output, sensor selection and memory maintenance. Label format commands are used in the definition of printing contents such as character data, bar code data, printing speed, and print density.

System level commands start with ASCII "SOH" (\$01) or ASCII "STX" (\$02).

Commands that start with "SOH" are requested for the real-time execution. When received, they are executed immediately even during printing. Commands that start with "STX" enter the buffer area and are executed in the order of data reception.

Label format commands follow the system level commands' "STX" + "L" and end with a "CR."

(For details, see 1.3 Outline of Interpreter and 1.4 Outline of Label Format Data.)

Fig. 1 Command summary

System level commands Start with "SOH" or "STX" and end with a "CR"	Commands which start with "SOH" Executed as soon as they are received (For example: printing halt, output of printer status, etc.)
	Commands which start with "STX" Executed in order after they are received into the reception buffer (For example: sensor switching, memory card maintenance, etc.)

"STX" + "L"

"E" (with printing)

"X" (without printing)

Label format commands End with a "CR"	Print parameter control
	Character data definition commands
	Bar code definition commands
	Graphic commands
	Other commands

1.3 Outline of Interpreter

Two types of interpreters are used for this printer; system level and label format interpreters. When power is turned on, the system level interpreter is selected and the data received is processed in the system level interpreter and system level commands are executed.

Changing to the label format interpreter to start generating label data is executed with system level commands. When the system level interpreter receives the system level command "STX" + "L," it changes to the label format interpreter. The commands after this are regarded as label format commands and label format starts.

The label format interpreter does not need headers such as "SOH" and "STX." The data for printing data format is delimited by a "CR" and then transmitted.

The label format command "E" or "X" executes changing to the system level interpreter from the label format interpreter. When label format ends with "E," defined data is printed and the system level interpreter is started. When label format ends with "X," the system level interpreter is started without printing.

1.4 Outline of Label Format Data

This printer prints label format data by using memory space of the following size.

area	Model			
	CL-S621 CL-S521	CL-S700 series	CLP-9301	CLP-8301
Reception buffer area [bytes]	16K	16K	16K	16K
Field register data area [bytes]	20K	20K	20K	20K
Number of maximum print fields	400	400	400	400
Global register area [bytes]	1K	1K	1K	1K
Bit map area [bytes]	1892K	1892K	1922K	4652K
Maximum page length [inches]	32	32	40	40

1 Reception buffer area

The reception buffer area is a ring data buffer area (software FIFO) under software control. Basically, all commands and data transmitted from the host computer are buffered once into this area and then executed in the order of buffering to complete communications from the host computer in the shortest possible time. However, some system level commands (such as those starting with "SOH" for print halt) which require real-time execution are executed immediately after being received.

2 Field register area

A string of character data and bar code data is regarded as one field that includes information such as type, print position, and size. The field register area is an area that encloses the label format field. The label format interpreter analyzes the format data received, stores it once, and then generates a bit map. If there are any problems in the data received, the data that is being analyzed is discarded without being stored in the field register area. The field data is given a control number for every field (1, 2, . . . 400) when the data is stored. This printer has a field register area of 20,000 characters and can print a maximum of 400 different types of field data per label.

3 Global register area

The global register area is an area which stores field data that is repeatedly used. A part of the data (character string and bar code data) in the field register is stored in the global register area and used as requested. The data stored in the global register area is given a control number starting with A (A, B, -----, P). The data set in the global register is stored while formatting for one label is performed (until the label format interpreter returns control to the system level interpreter) so it can be reused for data definition within the same label.

4 Bit map area

The bit map area is a buffering area for output data. The data in this area is generated by a rasterizer according to the data in the field data area and corresponds to individual dots that are generated on the label during printing. The data of the bit map area is printed on the label with high quality and at high speed by means of the printer control program and exclusive thermal control circuit.

1.5 Outline of Label Printing Method

This printer has two label printing methods, one is that all label format data received is printed, and the other is that format data which has been received beforehand, is printed or partially modified and printed.

1 All data received method

- ASCII code "STX" + "L" sets the printer to label format mode. The printer clears the field register area and control is transferred from the system level interpreter to the label format interpreter. At this time, use of label format commands is enabled.
- Printing data such as characters, bar codes and graphics is transmitted. Each data set has a special field structure that includes information such as print position and size. The label format interpreter, stored in the field register area checks the printing data received, and generation of bit map data is then started. Powerful commands such as specification of the number of copies, characters strings and automatic increasing or decreasing of bar code data are included in the label format commands. In addition, the format data stored in the global register area can be read out and used.
- After completing label formatting, an ASCII "E" is transmitted. The printer prints the labels specified by the data in the field register area and control is then returned from the label format interpreter to the system level interpreter.

2 Using formatted data

- In this mode, fixed format labels are printed. While label data formatting is completed, an ASCII "X" is transmitted instead of "E." The printer forms the field register area and completes formatting without printing and control is returned to the system level command processor. From this point on, the system level command processor allows the printer to print fixed format labels by using the format data in the field register area.
- If ASCII "STX" + "G" is transmitted to the system level command processor, the labels are printed according to the contents of the specified field register.
In addition, change of data and number of copies is provided. (Only data can be changed. Format information such as print position and size cannot be changed.) Printing with the "STX" + "G" command can be performed repeatedly.

1.6 Control Code Specification

1 Outline

- This printer is connected to the computer via a serial interface and prints characters and bar codes at the requested print position on the label.
- The printer has a data area of 20,000 characters. This character data can be stored in up to 400 different fields in single buffer mode (200 different fields in double buffer mode) Each field stores attributes such as print position, rotation angle, font specification, and expansion factor (called attribute information). Machine control commands for print density or printing speed setting are used in addition to printing data control commands.
- Basically, this printer prints labels by means of bi-directional communications with the computer via the serial interface. The printer not only prints data, but also transmits information such as label and printer settings to the computer. The computer and printer communicate so that the printer can receive correct data from the computer and perform optimum printing.

Also, the printer has the parallel interface (centronics) as a standard but in this case bi-directional communications are not used, so data cannot be transmitted from the printer.

1.6.1 System Level Immediate Execution Commands

These commands are executed as soon as the printer receives them. They begin with "SOH," i.e. [01].

Command reset	[01] #
Printer status transmission request (8-byte packet)	[01] A
Pause	[01] B
Stop/cancel	[01] C
SOH command shutdown	[01] D
Transmission of number of remaining sheets to be issued	[01] E
Printer status transmission request (1-byte packet)	[01] F
Error status transmission request (4-byte packet)	[01]

Command reset

Code	[01] #
Function	Initialized equivalent to power is turned on. Buffer and on-board memory contents are initialized. Command setting for previous commands is initialized.
Transmission data	(XOFF) T (XON) R (XON) for hardware reset.
Caution	Since printer executes reset immediately after receiving this command, it clears un-printed data in the reception buffer. When using this command, you are recommended to check printing completion first, then send this command. This command will let the printer off, thus ensure the printer is ready mode state before sending this command.

Printer status transmission request (8-byte packet)

Code	[01] A																								
Function	If this command is received, printer will send data on current printer status to the computer with the following 8 ASCII characters. <table><tr><td>1</td><td>Command interpreter in action</td><td>Y or N</td></tr><tr><td>2</td><td>Paper end</td><td>Y or N</td></tr><tr><td>3</td><td>Ribbon end</td><td>Y or N</td></tr><tr><td>4</td><td>Batch processing (printing)</td><td>Y or N</td></tr><tr><td>5</td><td>Printing</td><td>Y or N</td></tr><tr><td>6</td><td>Pause</td><td>Y or N</td></tr><tr><td>7</td><td>Waiting for peeling</td><td>Y or N</td></tr><tr><td>8</td><td>Spare</td><td>N (always)</td></tr></table>	1	Command interpreter in action	Y or N	2	Paper end	Y or N	3	Ribbon end	Y or N	4	Batch processing (printing)	Y or N	5	Printing	Y or N	6	Pause	Y or N	7	Waiting for peeling	Y or N	8	Spare	N (always)
1	Command interpreter in action	Y or N																							
2	Paper end	Y or N																							
3	Ribbon end	Y or N																							
4	Batch processing (printing)	Y or N																							
5	Printing	Y or N																							
6	Pause	Y or N																							
7	Waiting for peeling	Y or N																							
8	Spare	N (always)																							

After sending 8 ASCII characters, code [0D] hex is added. Y and N each is hex digit and [59] hex and [4E] hex.

Caution	Printer sends data on printer status to the computer as soon as it receives this command (in a period of approx. 150ms - 250ms). Therefore, the computer must be ready to receive data from the printer immediately after receiving this command.
----------------	---------------------------------------------------------------------------------------------------------------------------------------------------------------------------------------------------------------------------------------------------

Printer status

Relationship between command interpreter, batch processing and printing

Normal label printing puts the printer in the above status. The printer, however, operates with a double buffer, so if the next printing data is received during batch processing, both interpreter operation and batch processing (printing) may be performed simultaneously.

Difference between batch processing and printing

As shown in the diagram, printing start and stop may be repeated within a single cycle of batch processing. Therefore, use the operations properly (peeling, auto-cutter, etc.) as required.

Pause

Code [01] B

Function Printing temporarily stops and resumes. Toggles printer pause on and off. Pause on and off by using this command is performed in the same way as operated from the control panel. Pause on from the control panel can change to pause off with this command.

Stop/cancel

Code [01] C

Function Printing stops. Performed in the same way as operated from the Stop key on the control panel. With this command, printer stops on completion of the current printing label and will clear data in the reception buffer.

SOH command shutdown

Code [01] D

Function After receiving this command, printer ignores immediate execution commands starting with control code [01] even if those commands are received.

To send nothing for five seconds can automatically cancel the setting.

Transmission of number of remaining sheets to be issued

Code [01] E

Function If this command is received, printer will send data on the number of remaining sheets to be issued for the current printing to the computer with 4 ASCII characters.
The [0D] hex code is added to the end of the 4-digit transmission data.

Caution Printer sends data on the number of remaining sheets to be issued to the computer as soon as it receives this command (in a period of approx. 150ms - 250ms). Therefore, the computer must be ready to receive data from the printer immediately after receiving this command.

Printer status transmission request (1-byte packet)

Code [01] F

Function If this command is received, printer will send 1 -byte packet data on current printer status to the computer. The contents of 1-byte packet data transmitting from the printer are as follows:

Bit	Description	YES	NO
1	Command interpreter in action	1 or	0
2	Paper end	1 or	0
3	Ribbon end	1 or	0
4	Batch processing (printing)	1 or	0
5	Printing	1 or	0
6	Pause	1 or	0
7	Waiting for peeling	1 or	0
8	Spare		0 (always)

The [0D] hex code is added to the end of transmission data.

Caution Printer sends data on printer status to the computer as soon as it receives this command. Therefore, the computer must be ready to receive data from the printer immediately after receiving this command.

Error status transmission request (4-byte packet)

Code [01] I

Function After receiving this command, printer sends 4-byte data on current conditions inside the printer to the host PC. Shown below are contents of the 4-byte data to be sent from the printer.

Byte	Bit	Description	YES	NO
1	1	Battery exhaustion (Unsupported)	1	or 0
	2	Head at low temperature (Unsupported)	1	or 0
	3	Main PCB at low temperature (Unsupported)	1	or 0
	4	Wear and tear on a head	1	or 0
	5	Spare	0 (always)	
	6	Pause	1	or 0
	7	Fixed	1 (always)	
	8	Fixed	0 (always)	
2	1	Spare	0 (always)	
	2	Head overheat	1	or 0
	3	Spare	0 (always)	
	4	Spare	0 (always)	
	5	Mechanism is exposed.	1	or 0
	6	Paper end	1	or 0
	7	Fixed	1 (always)	
	8	Fixed	0 (always)	
3	1	Paper out	1	or 0
	2	Ribbon end	1	or 0
	3	Overheating of Main PCB (Unsupported)	1	or 0
	4	Spare	0 (always)	
	5	Abnormality in option boards (Unsupported)	1	or 0
	6	Abnormality in auto cutter	1	or 0
	7	Fixed	1 (always)	
	8	Fixed	0 (always)	
4	1	Fan motor stop (Unsupported)	1	or 0
	2	Spare	0 (always)	
	3	Spare	0 (always)	
	4	Spare	0 (always)	
	5	Spare	0 (always)	
	6	Error is occurring.	1	or 0
	7	Fixed	1 (always)	
	8	Fixed	0 (always)	

The [0D] hex code is added to the end of transmission data.

Caution

Printer sends data on printer status to the computer as soon as it receives this command. Therefore, the computer must be ready to receive data from the printer immediately after receiving this command.

1.6.2 System Level Occasional Execution Commands

These commands are executed as soon as the printer receives them. They begin with "STX," i.e. [02].

Setting date and time	[02] A
Setting feedback character transmission validness	[02] a
Date and time transmission request	[02] B
Setting paper length for continuous paper	[02] c
Setting two-page edit mode (double buffer)	[02] d
Changing number of prints for edited format	[02] E
Setting edge sensor selection	[02] e
Label one sheet feed	[02] F
Setting peeling (cutting) position	[02] f
Printing edited or formerly-printed format	[02] G
Graphics data block input command	[02] I
TrueType fonts downloading command	[02] i
Pause per label printing	[02] J
Extension system command (printer settings)	[02] KD
Extension system command (setting peeling or cutting position)	[02] Kf
Setting Y-code-transmission-to-serial-port request	[02] k
Specifying printing contents setting start	[02] L
Setting maximum label length	[02] M
Changing units from inch to metric system	[02] m
Changing units from metric to inch system	[02] n
Setting printing position	[02] O
Paper cut	[02] o
Setting dump mode start	[02] P
Pause in occasional execution	[02] p
Clearing all memory module contents	[02] Q
Clearing memory module contents	[02] q
Setting reflective paper sensor selection	[02] r
Setting paper feed speed	[02] S
Setting one-page edit mode (single buffer)	[02] s

Printing quality test pattern	[02] T
Rewriting specified format register contents	[02] U
Setting memory switch contents	[02] V
Printer version number transmission request	[02] v
Information-in-memory-module transmission request	[02] W
Testing flash memory	[02] w
Default module selection	[02] X
Clearing memory module contents (in file units)	[02] x
TrueType fonts Symbol Set Selection	[02] y
Printing printer status	[02] Z
Select Command Set	[02][1B] G
Setting printing methods	[02][1B] M
Head disconnection detection	[02][1B] T
Setting ejection (tear-off)	[02][1B] t
Setting label width	[02][1B] w

Setting date and time

Code	[02] A, w, mm, dd, yyyy, hh, MM, j j j
Setting	w Sun. 0 Mon . 1 Tue s. 2 Wed s. 3 Thu rs. 4 Fri. 5 Sat. 6
mm	Month 01 - 12
dd	Day 01 - 31
yyyy	Year 4 digits
hh	Hour (24-hour display)
MM	Minute 00 - 59
j j j	Spare 000 fixed
Function	Sets date and time on the calendar stored in the printer.
Example	Input data below represents 15:30 Saturday 7 July 2001.
Input data	[02]A6070720011530000

Setting feedback character transmission validness

Code	[02] a
Function	With this command, printer transmits [1E] every one label printing to the computer and on completion of one batch printing, [1 F] is transmitted to the computer.
	After one label printing [1E]
	On completion of one batch printing [1F]
	When receiving invalid label format command [07]
Caution	The [0D] hex code is not added to the end of the transmission data.

Date and time transmission request

Code [02] B

Data format w, mm, dd, yyyy, hh, MM, jjj

w Sun. 0 Mon. 1 Tue. 2 Wed. 3 Thu. 4
Fri. 5 Sat. 6

mm Month 01 - 12

dd Day 01 - 31

yyyy Year 4 digits

hh Hour (24-hour display)

MM Minute 00 - 59

jjj Total number of days from the 1st of January

Function Data on the contents of the calendar (date and time) stored in the printer is transmitted to the computer. Data format transmitted from the printer is described below. The [0D] hex code is added to the end of the transmission data.

Example Reception data below represents 15:30 Saturday 7 July 2001, which is transmitted from the printer.

Reception data 6070720011530188[0D]



Setting paper length for continuous paper

Code	[02] c nnnn
Unit	0.01 inch
Setting	nnnn 4-digit data Initialization value: 0000
	Inch system 0001 – 9999 (0.01 – 99.99 inches)
	Metric system 0001 – 9999 (0.1 – 999.9 mm)

Function Sets label length for continuous paper. Length of label format is specified with this command. Label is cut in the length with this setting when using auto-cutter. When using label paper, 0000 must be set.

Example Example of input data below represents paper length of 2.5 -inch setting.

Input data	[02] n	Sets units to inch system
	[02] c 0250	Sets paper length to 2.5 inches for continuous paper
	[02] L	Starts label format mode
	D11	Sets pixel size
	1F3306000500050490123456789	Sets EAN13 bar code for data "490123456789"
	E	Ends label format mode and prints



Setting two-page edit mode (double buffer)

Code [02] d

Function After receiving this command, printer divides the internal edit buffer into 2 pages and enters the high-speed edit mode.

In the high-speed edit mode, editing the next page in advance while the current page is being printed increases printing speed.

Caution The printer automatically judges whether the double buffer is needed or not, and the mode is switched accordingly, so this command does not need to be particularly specified. Maximum printing length per page is 40 inches, independently of the division.

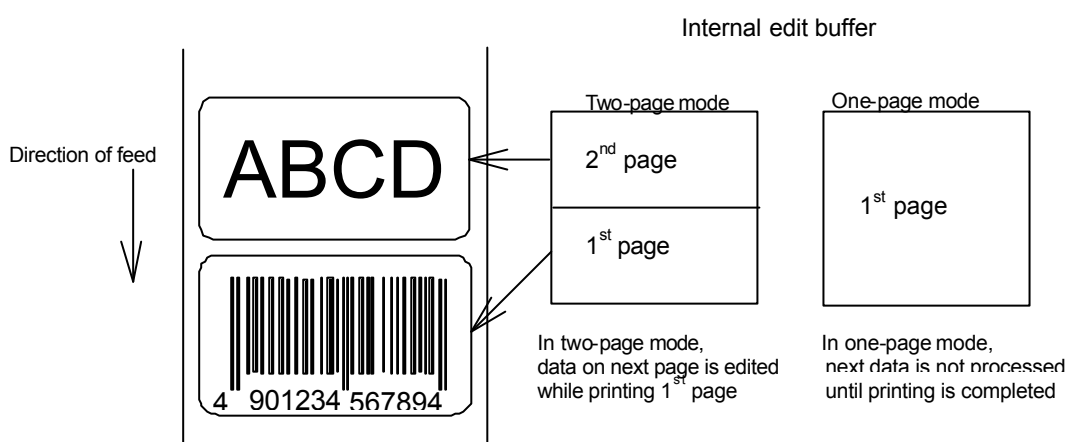

Changing number of prints for edited format

Code	[02] E nnnn	
Setting	nnnn	4-digit numeric 0001 - 9999
Function	Specifies changing of number of prints for formatted or formerly printed label format.	
Example	Input data below represents that after ending label format printing data "ABC" one sheet, the number of prints is set to 3 by using this command and printing is executed with [02] G command. (In this case, the number of prints is one plus three.)	
Input data	[02] n	Sets units to inch system
	[02] L	Starts label format mode
	D22	Sets pixel size
	190001001000050ABC	Sets character data "ABC" with smooth font 48pt
	E	Ends label format mode and prints
	[02] E0003	Sets 3-sheet printing for edited format
	[02] G	Executes 3-sheet printing for edited format

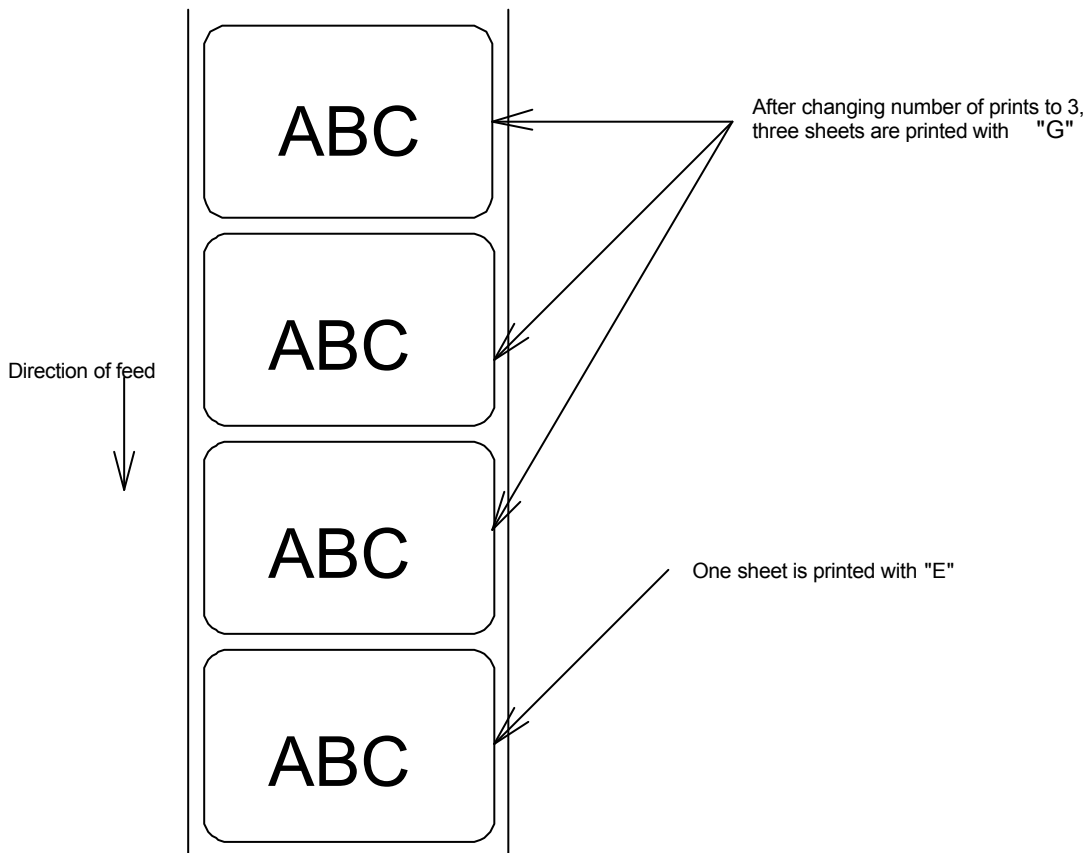

Setting edge sensor selection

Code [02] e

Function Changes paper position detection sensor to transparent-type.
Used for detecting paper gap between label papers, die-cut paper, notch hole for tag paper, etc. This setting is used as default.

Caution If not detected properly, check the sensor position.

Example Paper gap between label papers and notch holes for tag paper in Fig below is detected.

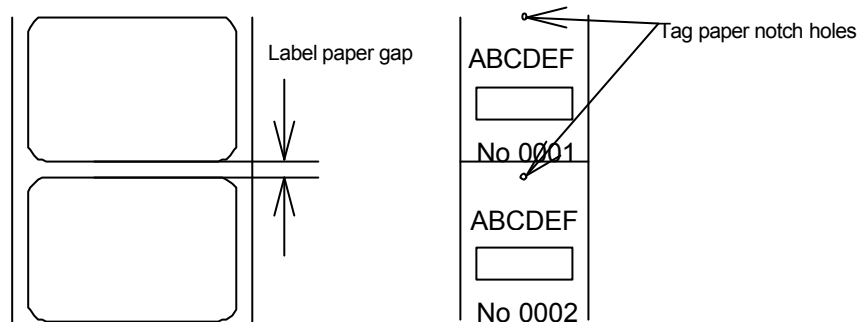

Label one sheet feed

Code [02] F

Function Feeds label one sheet. The amount of feed is the length from the bottom of the label paper to the next bottom of the label paper. When using continuous paper, feeds paper the length currently set ([02] c nnnn).

Performed in the same way as operated from the Feed key on the control panel.

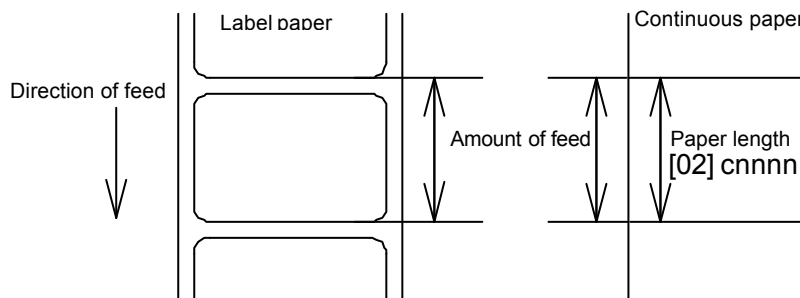

Setting peeling (cutting) position

Code [02] f nnn

Units 0.01 inch (0.1mm)

Setting nnn 3-digit data
Initial value and its set range vary depending on the command setting.

	Inch system			Metric system		
	Initial value	Minimum value	Max value	Initial value	Minimum value	Max value
DMI / DMW						
Normal	000	000	200	000	000	508
Cutter	100	000	200	254	000	508
Peel	050	000	150	127	000	381
Tear Off	070	000	170	178	000	432
DM4 / DM8						
Normal	220	220	420	559	559	1067*
Cutter	340	240	440	864	610	1118*
Peel	270	220	370	686	559	940
Tear Off	290	220	390	737	559	991
DPP						
Normal	110	110	310	279	279	787
Cutter	230	130	330	584	330	838
Peel	146	96	246	371	244	625
Tear Off	166	96	266	422	244	676

*In setting 4-digit value, use [02] Kf command.

Function With the setting above, the distance between paper sensor and cutter or peeler can be specified.

When nnn is small, the amount of feed is small, so printed label will be cut.

When nnn is appropriate, the label is fed the required amount, then cut at the paper gap.

When nnn is large, the amount of feed is large, so the next printing label will be cut.

Caution If value out of range is specified, the command parameter will be ignored.

If optional functions such as cutter, peeler and ejection are turned on from the control panel, their initialization values will be set automatically. These initialization values, however, vary depending on the specifications of each option. For details, see the instruction manuals of each option.

Once this command was set, auto-setting function is stopped due to priority for user's specification. Do not set this command if not necessary.

Figure

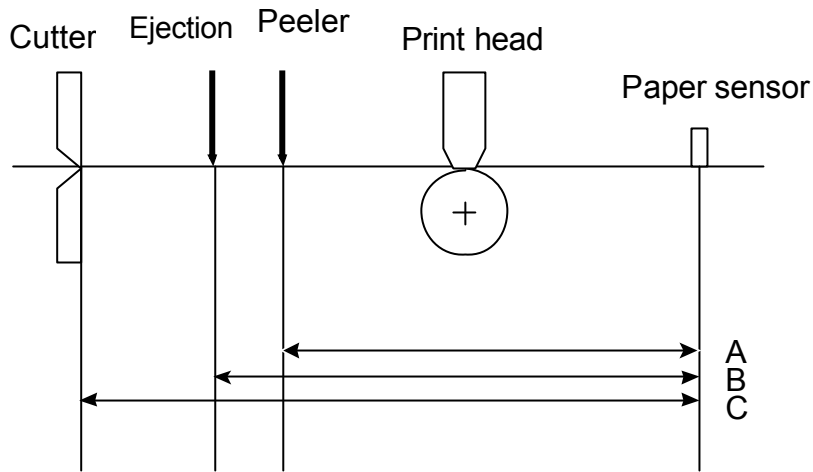

Note: Peeler option is not available for CLP-8301

Printing edited or formerly-printed format

Code [02] G

Function Prints label data for former printing or formatting.

Caution This command is effective only when label data for former printing or formatting is left in the internal memory. If power is turned off or reset is performed, data in the internal memory will be cleared, so this command will not be effective.

Example Input data below represents that after ending label format printing data "ABC" one sheet, printing for the same data is executed again with this command [02] G.

Input data	[02] n	Sets units to inch system
	[02] L	Starts label format mode
	D22	Sets pixel size
	190001001000050ABC	Sets character data "ABC" with smooth font 48pt
	E	Ends label format mode and prints
	[02] G	Executes 1-sheet printing for edited format

Graphics data block input command

Code [02] l m a f name, data

Transmission data m Storing memory module specification
Allocation of modules varies with command settings. Refer to the table below.

	Command Set		
Allocation of module	DMI / DMW	DM4 / DM8	DPP
on-board SD-RAM	D	A	B
on-board flash memory	G	B	A
PCMCIA Card (option)	E or F	E or F	E or F
Current memory module	on-board SD-RAM	on-board SD-RAM	on-board SD-RAM

f Graphics data format

F 7-bit image loading file

I 8-bit image format (image saved in reverse)

i 8-bit image format (image saved in normal)

B 8-bit BMP format (saved in normal)

b 8-bit BMP format (saved in reverse)

P 8-bit PCX format (saved in normal)

p 8-bit PCX format (saved in reverse)

Note: For graphics data format, refer to input data examples.

name File name for graphics data (up to 16 characters ending with CR)

data Graphics data for each format

Function Stores specified format data in the specified memory module.

Caution In the 8-bit BMP format and PCX format, data in colors other than black-and-white (two colors) cannot be used. Color or gray -scale data must be converted to black-and-white before use.

If the same file name as that of the current file is used for storing its data in the memory module, the contents of the current file will be replaced by the new image file. (Note: Working memory space is required for new image file.) Therefore, if overwrite is repeated, the data will not be stored due to lack of memory capacity. In this case, packing the data with command [02] z may store the data in the memory module.

7-bit image loading file format

7-bit image data uses ASCII format data. In this example, 7-bit image data with the file name of "MARK7" is stored in the memory card and printed out. Value of inside [] is shown in hex format.

```
[02]IBFMARK7 ----- Graphics data input command
8006000041040000 -----After this, 7-bit image data follows
80060000C30C0000         Top data "80" is a starting code for image data
8006000186180000         Next data      "06" following "80" is the number of data in
800600030C300000         horizontal direction
800600071C700000
8006000618600000
8006000618600000
8006000618600000
8006000618600000
800600030C300000
800600030C300000
8006000186180000
80060001C71C0000
80060000C30C0000
80060000C30C0000
80060000C30C0000
80060030C30CC000
800600F18618F000
800603E186187C00
800607830C301E00
8006070F3CF00E00
80060E1E79E00700
80060C3861800300
80061C0000000380
80061C0000000380
80060C0000000300
80060E0000000700
8006070000000E00
8006078000001E00
800603E000007C00
800601F80001F800
800600FC0007F000
8006003F803FC000
8006000FFFFF0000
80060003FFFC0000
800600007FE00000
FFFF ----- Graphics data ending code
[02] m
[02] M1500 ----- Sets maximum label length
[02] L ----- Starts label format
D22
1Y1100001000500MARK7 ----- Develops " MARK7" graphics data to specified position
E ----- Starts printing
```

8-bit image format

8-bit image data uses ASCII format data. In this example, 8-bit image data with the file name of "MARK8" is stored in the memory card and printed out. Value of inside [] is shown in hex format. (Note: Data below is described in hex.)

```
[01][44][0D]----- Stops immediate execution command
                                Required only for 8-bit image data)
[02][49][42][69][4D][41][52][4B][38][0D]----- Graphics
[00][01][00][08][00][01][00][02][00][7F][00][7F][00][E0][00][24]-----
[80][06][00][00][41][04][00][00] -----
[80][06][00][00][C3][0C][00][00]
[80][06][00][01][86][18][00][00]
[80][06][00][03][0C][30][00][00]
[80][06][00][07][1C][70][00][00]
[80][06][00][06][18][60][00][00]
[80][06][00][06][18][60][00][00]
[80][06][00][06][18][60][00][00]
[80][06][00][06][18][60][00][00]
[80][06][00][03][0C][30][00][00]
[80][06][00][03][0C][30][00][00]
[80][06][00][01][86][18][00][00]
[80][06][00][01][C7][1C][00][00]
[80][06][00][00][C3][0C][00][00]
[80][06][00][00][C3][0C][00][00]
[80][06][00][00][C3][0C][00][00]
[80][06][00][30][C3][0C][C0][00]
[80][06][00][F1][86][18][F0][00]
[80][06][03][E1][86][18][7C][00]
[80][06][07][83][0C][30][1E][00]
[80][06][07][0F][3C][F0][0E][00]
[80][06][0E][1E][79][E0][07][00]
[80][06][0C][38][61][80][03][00]
[80][06][1C][00][00][00][03][80]
[80][06][1C][00][00][00][03][80]
[80][06][0C][00][00][00][03][00]
[80][06][0E][00][00][00][07][00]
[80][06][07][00][00][00][0E][00]
[80][06][07][80][00][00][1E][00]
[80][06][03][E0][00][00][7C][00]
[80][06][01][F8][00][01][F8][00]
[80][06][00][FC][00][07][F0][00]
[80][06][00][3F][80][3F][C0][00]
[80][06][00][0F][FF][FF][00][00]
[80][06][00][03][FF][FC][00][00]
[80][06][00][00][7F][E0][00][00]
[46][46][46][46] ----- Graphics data ending code
[02] m [0D]
[02] M1500 [0D]----- Sets maximum label length
[02] L [0D] ----- Starts label format
1Y1100001000500MARK8[0D] ---- Develops " MARK8" graphics data to specified position
E [0D] ----- Starts printing
```

Data on header is fixed except for the last 2 bytes, i.e., "00" "24" (36 lines in this example)

After this, 8-bit image data follows
Top data "80" is a starting code for image data
Next data "06" following "80" is the number of data in horizontal direction

Download of TrueType Font

Code [02] i m T nn name <CR> xxxxxxxx data...

Transmission data m Storing memory module specification

Allocation of modules varies with command settings. Refer to the table below.

Allocation of module	Command Set		
	DMI / DMW	DM4 / DM8	DPP
on-board SD-RAM	D	A	B
on-board flash memory	G	B	A
PCMCIA Card (option)	E or F	E or F	E or F
Current memory module	on-board SD-RAM	on-board SD-RAM	on-board SD-RAM

T T fixed (TrueType)

nn Two-digit font ID

Valid values: 50 – 59, 5A – 5Z, 5a – 5z,

60 – 69, 6A – 6Z, 6a – 6z,

:

90 – 99, 9A – 9Z, 9a – 9z

name Font name (Max. 16 characters followed by CR code to end)

xxxxxxx TrueType font data size, number of bytes assigned by 8 digits hexadecimal characters.

data TrueType font data

Function Stores specified font data in the specified memory module.

Caution File will be overwritten when the font data is stored in the memory module using the same name of the existing file. Therefore, free space for the file to write new data will be necessary.

Example The following command line shows the command to download 34754 bytes of TrueType font file, named “Tree Frog”, with the font ID 52 into the memory module B:

Input data [02] iCT52TreeFrog<CR>000087C2 data...

Pause per label printing

Code [02] J

Function Performs pause each time label is printed one sheet. Used when label peeling detection sensor is not mounted on the printer incorporating peeling function. Pause is cancelled by pressing Pause key on the control panel.

Caution To clear this function, reset the printer.

Extension system command (printer settings)

Code	[02] Kdabc
Transmission data	Printer setting parameter a Hex notation for the following bit settings bit 0-2 baud rate case bit 4 = 0 0=9600*, 1=600, 2=2400, 3=4800, 5=300, 6=1200, 7=9600 test mode case bit 4 = 1 0=115200, 1=57600, 2=38400, 3= none, 5=none, 6= none 7= none bit 3 character length 0=8 bits*, 1=7 bits bit 4 Extended baud rate 0=OFF*, 1=ON bit 5 (not used) always 0 bit 6 (fixed) always 1 bit 7 (fixed) always 0 b Hex notation for the following bit settings bit 0 printing method 0=thermal, 1=thermal transfer* bit 1 peeling sensor 0=OFF*, 1=ON bit 2 (not used) always 0 bit 3 auto-cutter 0=OFF*, 1=ON bit 4-5 (not used) always 0 bit 6 (fixed) always 1 bit 7 (fixed) always 0 c Hex notation for the following bit settings bit 0-1 type of paper 0=transparent*, 1=reflective, 2=continuous (3 inches) bit 2-5 (not used) always 0 bit 6 (fixed) always 1 bit 7 (fixed) always 0 (*: factory setting)
Function	Provides various printer settings.
Caution	This setting is stored even when the power is turned off.
Example	[02]KD@A@[0D] @: 9600 baud, 8-bit length, no parity A: thermal, no peeling sensor, no auto -cutter @: transparent paper [02]KDP@B[0D]

P: 115200 baud, 8-bit length, no parity
@: thermal transfer, no peeling sensor, no auto-cutter
B: continuous paper

Setting peeling (cutting) position

Code	[02] Kf nnnn
Units	0.01 inch (0.1mm)
Setting	nnnn 4-digit data
	Inch system 0001 - 9999 (0.01 – 99.99 inches)
	Metric system 0001 - 9999 (0.1 – 999.9 mm)
Function/ Caution	Command is valid only for DMI/DMW mode. It has the same function as that of [02] fnnn. For details, refer to [02] fnnn command.

Setting Y-code-transmission-to-serial-port request

Code	[02] k
Function	After receiving this command, printer issues "Y"(59hex) code via serial port. This allows printer and computer to synchronize each other.
Caution	[0D] hex code is not added to the end of the "Y"(59hex) code.

Specifying printing contents setting start

Code [02] L

Function With this command input, printer enters the label format mode and waits for input of printing contents definition and label format commands until it receives "E" "s" or "X" code.

Example Input data below represents that label format command input is started, data "ABC" is defined as printing contents, label format command input is completed, and label printing command "E" is entered.

Input data	[02] n	Sets units to inch
	[02] L	Starts label format mode
	D22	Sets pixel size
	190001001000050ABC	Sets character data "ABC" with smooth font 48pt
	E	Ends label format mode and prints

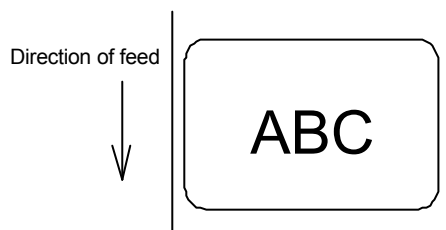

Setting maximum label length

Code	[02] M nnnn
Units	0.01 inch or 0.1 mm
Setting	nnnn 4-digit data Initialization value: 1000 (10.00 inches) Max. value: Inch system 9999 (99.99 inches) Metric system 9999 (99.9 mm)

Function Sets maximum label length for detecting label out. If printer cannot detect the next top of the label within the maximum label length which has been set with this command, "M" command error occurs. Set value 2.5 to 3 times as large as the label length to be used.

Example If label length is 2.5 inches, the value more than double 2.5 inches must be set for maximum label length. But if label length is 1.1 inch or less, the value more than triple must be set for maximum label length.
Input data below is for 3.5-inch setting

Input data	[02] n	Sets units to inch system
	[02] M 0350	Sets 3.5 inches for maximum label length
	[02] L	Starts label format mode
	D11	Sets pixel size
	1F3306000500050490123456789	Sets EAN13 bar code for data "490123456789"
	E	Ends label format mode and prints

Initialization value for printer maximum label length is set to 10 inches (254 mm). If longer label length is required, using the maximum label length command must set the value larger than the length of printing. If the length of printing is larger than the maximum label length, set the M command as follows:

Maximum label length [02] M nnnn > length of printing

Note: If label paper mode is continuous paper, this command is ignored.

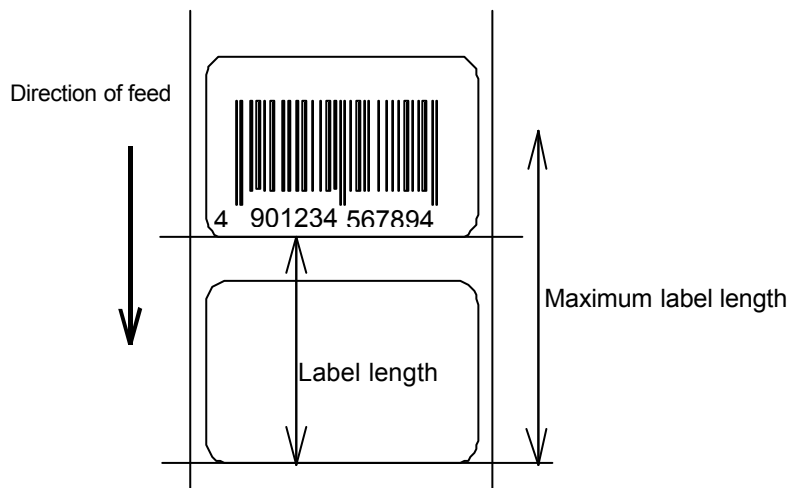

Changing units from inch to metric system

Code	[02] m	
Function	Changes units for all -distance-specified-command-parameters from 0.01 inch to 0.1 mm. With reset, units are set to metric system.	
Example	Input data below represents that data "ABC" is specified with units in metric system.	
Input data	[02] m	Sets units to metric system
	[02] L	Starts label format mode
	D22	Sets pixel size
	190001001000050ABC	Sets character data "ABC" with smooth font 48pt
	E	Ends label format mode and prints

Printing results of the same data with or without units of metric system are as follows:

Changing units from metric to inch system

Code	[02] n	
Function	Changes units for all -distance-specified-command-parameters from 0.1 mm to 0.01 inch. With reset, units are set to inch system.	
Example	Input data below represents that data "ABC" is specified with units of inch.	
Input data	[02] n	Sets units to inch
	[02] L	Starts label format mode
	D22	Sets pixel size
	190001001000050ABC	Sets character data "ABC" with smooth font 48pt
	E	Ends label format mode and prints

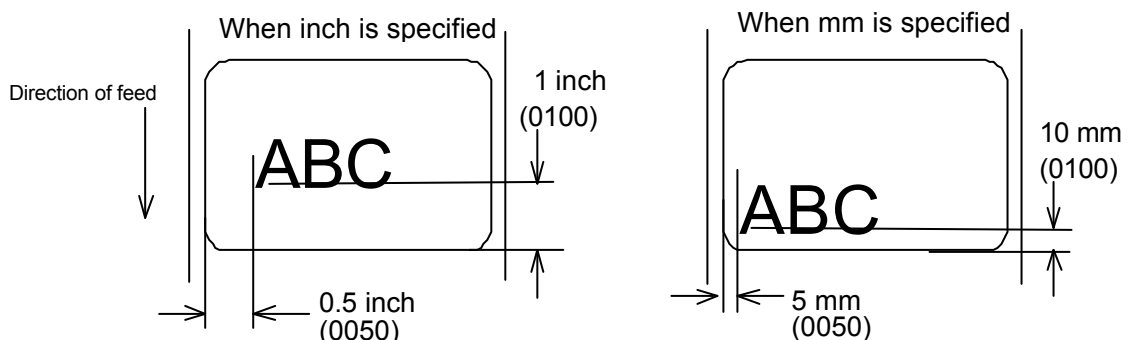

Setting printing position

Code [02] O nnnn

Units 0.01 inch or 0.1 mm

Setting nnnn 4-digit data
Initial value and its set range vary depending on the command set.

Command Set	Inch system			Metric system		
	Initial value	Minimum value	Max value	Initial value	Minimum value	Max value
DMI / DMW	0220	0120	0320	0559	0305	0813
DM4 / DM8	0220	0120	0320	0559	0305	0813
DPP	0110	0010	0210	0279	0025	0533

Function Specifies the distance between paper sensor and print head. By changing this value, a physical printing start position can be changed.

Caution If value less than 0.5 inch (0050) is specified, the initialization value will be set automatically. With the initialization value set, printing starts from the bottom of the label. If the command is used after completing printing, this command setting will not be effective to the first sheet of the label. From the second sheet of the label, this will be effective.

Figure

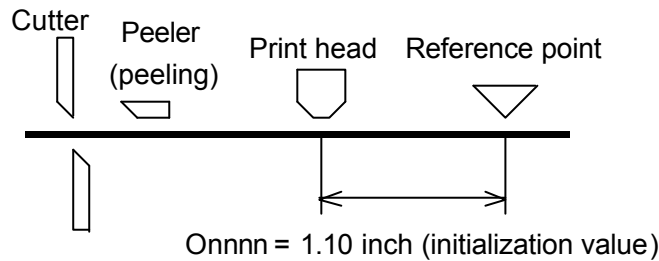

Paper cut

Code	[02] o
Function	When mounting auto-cutter, if this command is received, the label or paper cutting will be performed once.
Caution	If auto-cutter is not turned to ON, this command will be ignored. Set the cutting sheet number to 0 (zero) with the specified command (cnn or :nnnn). Otherwise, each label will be cut automatically.

Setting dump mode start

Code	[02] P
Function	By receiving this command, printer enters the dump mode. After that, all data transmitted from the computer are printed out with hex code. To escape from the dump mode, turn on and off the power or turn the "Hex Dump" mode off by the operation panel.
Example	Input data below represents that label format command input is started, data "ABC" is defined as printing contents, label format command input is completed, and label printing command "E" is entered.
Input data	[02] P Sets dump mode [02] L Starts label format mode 190001001000050ABC Sets character data "ABC" with smooth font 48pt E Ends label format mode and prints

Direction of feed
↓

DUMP LIST

```
0D024C0D4431310D3139313130313030..L.D11.19110100
313030303035304142430D450D            1000050ABC.E.
```

Pause in occasional execution

Code	[02] p
Function	Executes pause occasionally.
Caution	Pause on and off cannot be performed with this command. Cancelling pause must be operated from the Pause key on the control panel.

Clearing all memory module contents

Code	[02] Q
Function	Clears all data in on-board flash memory and on-board SD-RAM and option memory card modules.
Caution	Clearing of all memory module contents takes about 15 seconds. For models with an LCD, "On Line" appears on the LCD as soon as the module contents are cleared.

Clearing memory module contents

Code [02] q n

Setting n Memory module specification parameter

Allocation of modules varies with command settings. Refer to the table below.

Allocation of module	Command Set		
	DMI / DMW	DM4 / DM8	DPP
on-board SD-RAM	D	A	B
on-board flash memory	G	B	A
PCMCIA Card (option)	E or F	E or F	E or F
Current memory module	on-board SD-RAM	on-board SD-RAM	on-board SD-RAM

Function Clears all data in memory module.

Caution Clearing of on-board flash memory module takes about 10 seconds. For models with LCD, "On Line" appears on the LCD as soon as the module contents are cleared.

Input data [02] q B Sets clearance of module B (on-board SD-RAM) contents.

Setting reflective paper sensor selection

Code [02] r

Function Detects label position automatically by reflective paper sensor. Reflective paper sensor detects black lines that are printed on the back of the label and understands the label position. In default, reflective paper sensor is selected.

Caution When detection is not performed properly, check the sensor position.

Example As shown in the figure below, label position is detected with the black lines on the back of the label.

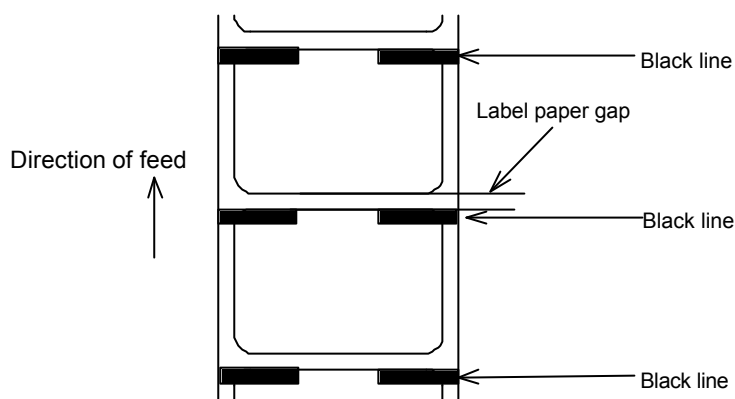

* Figure above shows the back of the paper

Setting paper feed speed

Code	[02] Sa
Setting	a Paper feed speed specifying character
A or B or 1	2 .0 inches (50.8 mm)/sec
C or D or 2	2 .0 inches (50.8 mm)/sec
E or F or 3	3 .0 inches (76.2 mm)/sec
G or H or 4	4 .0 inches (101.6 mm)/sec
I or J or 5	5 .0 inches (127.0 mm)/sec
K or L or 6	6 .0 inches (152.4 mm)/sec
M or N or 7	7 .0 inches (177.8 mm)/sec
O or P or 8	8 .0 inches (203.2 mm)/sec
Q or R or 9	9 .0 inches (228.6 mm)/sec
S or T or a	10 .0 inches (254.0 mm)/sec
U or V or b	11 .0 inches (279.4 mm)/sec
W or c	12 .0 inches (304.5 mm)/sec

Note: Initial value and maximum value vary depending on the printer model.

Function Sets paper feed speed.

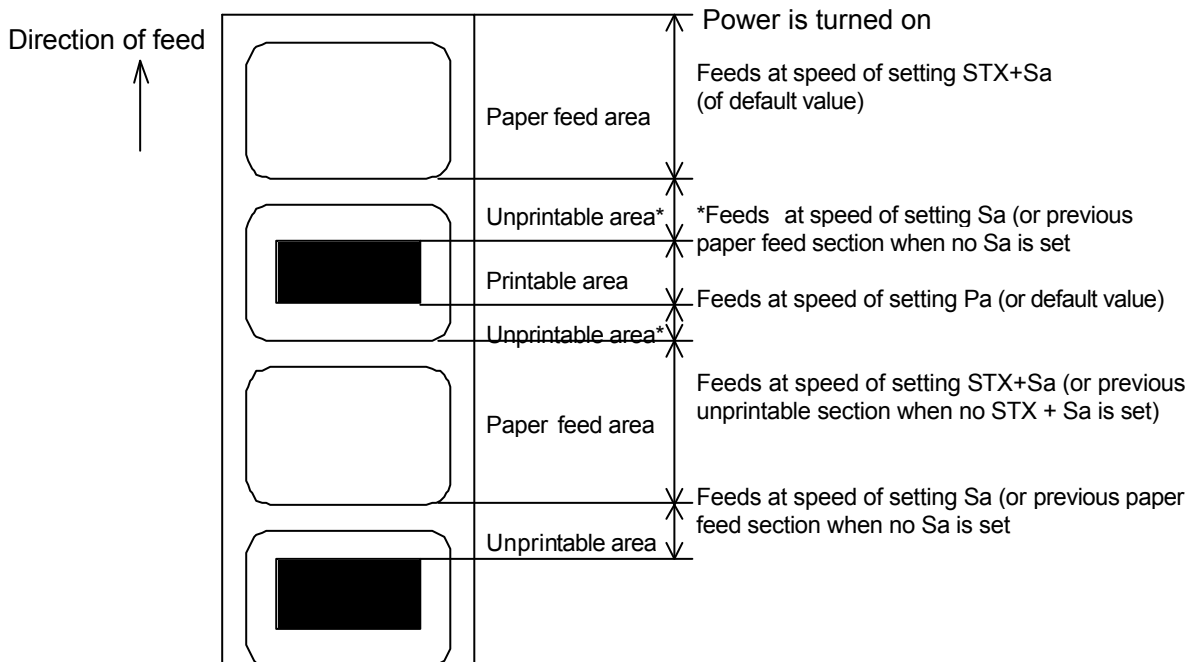

Setting one-page edit mode (single buffer)

Code	[02] s
Function	After receiving this command, printer makes the internal edit buffer one page. At this time, the maximum printing length on one page is 40 inches. In initialization after turning on power, this mode is set.
Caution	The printer automatically judges whether the single buffer is needed or not, and the mode is switched accordingly, so this command does not need to be particularly specified. Maximum printing length per page is 40 inches.

Printing quality test pattern

Code	[02] T
Function	After receiving this command, printer prints out the quality test pattern to check whether printer is in good condition and not involved in troubles such as head disconnection. This test pattern is the same as the print pattern by the self-test.

Rewriting specified format register contents

Code	[02] U nnaa..	
Setting	nn 2-digit format register numbers 01 - 99 Printer sets format register numbers in sequence when label format is executed. aa Input character string data ending with CR code (0D hex) instead of old data. Basically the number of characters must be the same as the old data. But if it is small, rewriting can be executed.	
Function	Changes some part of the formerly printed label format or formatted label contents and prints it again.	
Example	Input data below represents that data "0001" and "ABC" are set on the fields No. 01 and No. 02 respectively and label is printed and then with this command, the data contents of the fields No. 01 and No. 02 are changed to "9999" and "GHIJK" and printed.	
Input data	[02] n	Sets units to inch
	[02] L	Starts label format mode
	D11	Sets pixel size
	1611000000000500001	Sets data "0001" on fields No. 01
	161100000300050ABCDE	Sets data "ABCDE" on fields No. 02
	E	Ends label format mode and prints
	[02] U019999	Changes data on fields No. 01 to "9999"
	[02] U02GHIJK	Changes data on fields No. 02 to "GHIJK"
	[02] G	Prints edited format

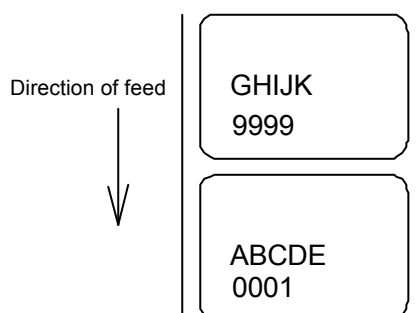

Setting memory switch contents

Code [02] V n

Setting n is hex data expressing switch on and off with binary. Appropriate ASCII codes are used for setting.

	Bit	0	1	2	3	4	5	6	7
Auto-cutter	1		○		○		○		○
Ribbon end sensor	Not care								
Peeling sensor	3					○	○	○	○

Function With this command, memory switch contents can be changed temporarily.

Example When auto-cutter is turned to ON, n = 1 (binary 0001), i.e., 1 for hex, so ASCII code 31hex is set. When peeling sensor is turned to ON, n = 4 (binary 0100), i.e., 4 for hex, so ASCII code 34hex is set.

Input data When auto-cutter is turned to ON: [02] V 1

When peeling sensor is turned to ON: [02] V 4

Printer version number transmission request

Code [02] v

Function After receiving this command, printer transmits the control ROM version number and date to the computer in ASCII code.

Caution Printer sends data on printer status to the computer as soon as it receives this command. Therefore, the computer must be ready to receive data from the printer immediately after receiving this command.

The [0D] hex code is added to the end of the transmission data.

Information-in-memory-module transmission request

Code	[02] W n
Setting	n F, G, L F Transmits downloading font information. G Transmits graphic image file information. L Transmits format (label printing contents) information.
Function	Transmits file name and memory remaining capacity in the currently installed memory module to the computer in ASCII code.
Caution	The [0D] hex is added to the end of the transmission code.
Example	Reception data below represents that file name "ABC.DAT" is set on the module A and transmitted by printer.
Input data	[02] WG
Reception data	MODULE: A [0D] ABCDAT[0D] AVAILABLE BYTES IN MODULE: 00496720[0D] MODULE: B [0D] AVAILABLE BYTES IN MODULE: 00524288 [0D]

Testing flash memory

Code	[02] w
Function	After receiving this command, printer tests flash memory module and transmits capacity and test results (GOOD or BAD).
Caution	The [0D] hex is added to the end of the transmission data. Also, memory card is initialized with this command. If no flash memory card is installed, nothing will be returned. And if the write-protect switch of the flash memory card is turned to ON, the test results are always BAD.
Reception data	MODULE B: xxxxK Flash Tested Good [0D]

Default module selection

Code [02] X a

Setting a Default module selection

Allocation of modules varies with command settings. Refer to the table below.

	Command Set		
Allocation of module	DML / DMW	DM4 / DM8	DPP
on-board SD-RAM	D	A	B
on-board flash memory	G	B	A
PCMCIA Card (option)	E or F	E or F	E or F
Current memory module	on-board SD-RAM	on-board SD-RAM	on-board SD-RAM

Function Selects default module. If default is set with other command module parameter, the module selected with this command is used. (E.g., [02] Imfaa, [02] qn, snaa..a, etc.)

Example Input data below represents that default module A is selected and default module is cleared.

Input data [02] X A Selects default module A.

[02] q C Clears default module.

Clearing memory module contents (in file units)

Code [02] xntname

Transmission data m Memory module specification parameter

Allocation of modules varies with command settings. Refer to the table below.

Allocation of module	Command Set		
	DMI / DMW	DM4 / DM8	DPP
on-board SD-RAM	D	A	B
on-board flash memory	G	B	A
PCMCIA Card (option)	E or F	E or F	E or F
Current memory module	on-board SD-RAM	on-board SD-RAM	on-board SD-RAM

T File format
 F Download font
 G Graphics data
 L Label format
 S TrueType font

Name File name (up to 16 characters ending with CR)

Bit mapped download font ID is three digits and TrueType download font ID is two digits.

Function The data in a memory module is cleared per file.

Example The graphic image file "MARK8" which exists in Module B is cleared.

Input data [02] xBGMARK8 [0D]

TrueType font symbol set selection

Code [02] ySxx

Setting S S fixed

xx Specification of a symbol set

The character sequence of 2 figures

(Refer to the following table for a setting value.)

Function Selection of a TrueType font symbol set

Caution It depends on each TrueType font file for the symbol set which becomes actually effective.

Example PC-850 multilingual is chosen.

Input data [02] ySPM

Table

XX	Font name	XX	Font name
US	ISO 6: ASCII (standard)	PE	PC-852 Latin 2
DN	ISO 60: Danish/Norwegian	W1	Windows 3.1 Latin 1
IT	ISO 15: Italian	PD	PC-8 D/N, Code Page 437N
GR	ISO 21: German	PC	PC-8 Code Page 437
FR	ISO 69: French	MC	Macintosh
E5	ISO 8859/5 Latin 5	SW	ISO 11: Swedish
E2	ISO 8859/2 Latin 2	SP	ISO 17: Spanish
E1	ISO 8859/1 Latin 1	UK	ISO 4: United Kingdom
DT	DeskTop	TS	PS Text
LG	Legal	WE	Windows 3.1 Latin 2
R8	Roman-8	WO	Windows 3.0 Latin 1
PT	PC-8 TK, Code Page 437T	PI	PI font
PM	PC-850 Multilingual		
WT	Windows 3.1 Latin 5		

Printing printer status

Code [02] Z

Function Performs test printing for indicating printer status.

Select Command Set

Code [02] [1B] G n

Setting n 0, 1, 2
0 : DMI or DMW
1 : DM4 or DM8
2 : DPP

Function Selects proper command set for your application.

Caution Switching command sets will change the designated destination of memory module and paper position. Check the command set if something is wrong with the destination and location of files.

Example Shown below are examples of input data when command set is DMI (DMW) or DPP.

Input data [02][1B]G0 When command set DMI(DMW)is specified.
[02][1B]G2 When command set DPP is specified.

Setting Printing Method

Code	[02] [1B] Mn												
Setting	n T, D T : Thermal transfer D : Heat-sensitive												
Function	Designates the printing method to be set; thermal transfer mode where a ribbon is used, or heat -sensitive mode where heat -sensitive paper is used.												
Example	Shown below are examples of input data when printing in thermal transfer mode.												
Input data	<table> <tr> <td>[02] n</td> <td>Sets units to inch</td> </tr> <tr> <td>[02][1B] MT</td> <td>Sets printing method to thermal transfer mode.</td> </tr> <tr> <td>[02] L</td> <td>Starts label format mode</td> </tr> <tr> <td>D22</td> <td>Sets pixel size</td> </tr> <tr> <td>191101001000050ABC</td> <td>Sets character data "ABC" with smooth font 48pt</td> </tr> <tr> <td>E</td> <td>Ends label format mode and prints</td> </tr> </table>	[02] n	Sets units to inch	[02][1B] MT	Sets printing method to thermal transfer mode.	[02] L	Starts label format mode	D22	Sets pixel size	191101001000050ABC	Sets character data "ABC" with smooth font 48pt	E	Ends label format mode and prints
[02] n	Sets units to inch												
[02][1B] MT	Sets printing method to thermal transfer mode.												
[02] L	Starts label format mode												
D22	Sets pixel size												
191101001000050ABC	Sets character data "ABC" with smooth font 48pt												
E	Ends label format mode and prints												

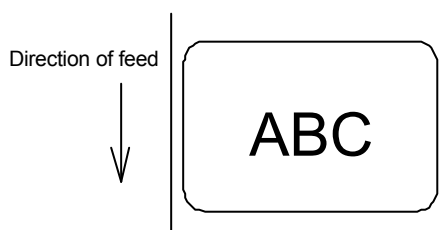

Head disconnection detection

Code	[02] [1B] T
Function	Measures resistance value per dot on head heat -generation part and checks whether head heat -generation part (resistance value) is normal. If it is normal, [01] is transmitted to the computer and if it is abnormal, [00] is transmitted to the computer.
Caution	The [0D] hex code is not added to the end of the transmission data.

Setting ejection (tear-off)

Code	[02] [1B] tn
Setting	n 0 , 1 0 : Ejection is turned to OFF 1 : Ejection is turned to ON
Function	Switches ejection ON and OFF. The contents with this command are stored in the backup memory and kept valid even if the power is turned off.
Caution	When the auto -cutter and peeling sensor are turned to ON, any ejection is not performed even if ejection is turned to ON because the auto-cutter and peeling sensor have priority. Setting of ejection, however, is kept valid because it is stored in the backup memory, so ejection will be performed when both auto -cutter and peeling sensor are turned to OFF.
Example	Examples of input data when Ejection ON and OFF are shown below.
Input data	[02][1B] t1 When specifying Ejection ON [02][1B] t0 When specifying Ejection OFF

Setting label width

Code	[02] [1B]w nnnn
	In inch unit mode, nnn n is defined as nn.nn inch, in metric unit, nnnn is defined as nnn.n mm
Unit	0.01 inch or 0.1 mm
Setting	nnnn 4-digit data Initialization value: depending on the printer Inch system 0000 – 9999 (0 inch - 99.99 inches) Metric system 0000 – 9999 (0 mm - 999.9 mm) Note: Maximum setting value will be different depending on the the printer model .
Function	Sets label width. Width of label format is specified with this command. When receiving this command, the printer will be operated as follows. The label width set by the operation panel will be ignored. The print buffer will be cleared and repeat operation will be cancelled. Maximum label length will be set automatically depending on the selected paper width.
Example	Example of input data below represents paper width of 4 inch setting.
Input data	[02] n Sets units to inch system [02] [1B]w0400 Sets paper width to 4 inches
Caution	When the parameter number is out of specified range will be ignored.

1.6.3 Label Format Commands

The following commands will be valid if the label format command interpreter is turned on with "STX" + "L," i.e. [02] L.

Set format attribute	A
Set format attribute	[1B]B
Setting offset in direction of column	C
Setting number of cuts (2-digit)	c
Setting pixel size in horizontal and vertical direction	D
Completion of setting printing contents (field preparation) and printing labels	E
Entering previous-defined field character string into global table	G
Setting print density (head heat factor)	H
Changing units from inch to metric system	m
Changing units from metric to inch system	n
Setting printable area speed	P
Setting backfeed speed	p
Specifying space between characters	[1B]P
Setting number of prints	Q
Setting offset in direction of row	R
Calling label format	r
Setting unprintable area speed	S
Storing label format	s
Specifying ending code	T
Setting previous field to character -string-replacement-mode field	U
Completion of setting printing contents (field preparation)	X
TrueType font symbol setting	y
Setting slash zero	z
Setting addition of previous -defined printing contents (field data) 1	+
Setting subtraction of previous -defined printing contents (field data) 1	-
Setting addition of previous -defined printing contents (field data) 2	>
Setting subtraction of previous -defined printing contents (field data) 2	<

Setting number of prints for same label	^
Setting number of cuts (4-digit)	:
Character field definition	1n..
Bar code field definition	
Ruled line definition	1X..L
Box definition	1X..B
Polygon definition	1X..P
Circle definition	1X..C
Graphics printing definition	1Y..
Reading out from global register	1n.. [02]S
Date and time printing definition	1n.. [02]T

Set format attribute

Code	An
Setting	n 1, 2, 3, 5 1 : All data should be formed by XOR processing In this mode, the area where text strings, images or barcodes intersect will not be printed. 2 : All data should be formed by OR processing. In this mode, the area where text strings, images or barcodes intersect will be printed. 3 : Following data should be formed by overlay processing * Human readable character and barcode * Image and drawing data In this mode, first text format is covered by the text formatted last. 5 : Following data should be printed in reverse. * Human readable character and barcode * Image data Note: Reversed data should be formed by XOR processing. Other data should be formed by XOR processing.
Function	Specifies development method for character and bar code.

Set format attribute

Code	[1B] B n 1B is hex code.
Setting	n 0, 1 Initialization value: 0 0 Specifies XOR development and character and bar code overlaid are reversed out of black. 1 Specifies OR development and character and bar code are overlaid.
Function	Specifies development method for character and bar code.

Setting offset in direction of column

Code	C nnnn		
Units	0.01 inch or 0.1 mm		
Setting	nnnn	4-digit data	Initialization value: 0000
		Inch system	0000 - 9999 (0.00 inch - 99.99 inches)
		Metric system	0000 - 9999 (0.0 mm - 99.9 mm)
Function	Sets offset value for printing start position in direction of column (paper left and right) to adjust the position of the total printing contents.		
Example	Shifts label printing position 1.0 inch (C0100) rightward and prints.		
Input data	[02] n		Sets units to inch
	[02] L		Starts label format mode
	D11		Sets pixel size
	C0100		Sets column offset to 1.0 inch
	190000501150090ABC		Sets character data "ABC" with smooth font 14pt
	1F3306000500050490123456789		Sets EAN13 bar code for data "490123456789"
	E		Ends label format mode and prints

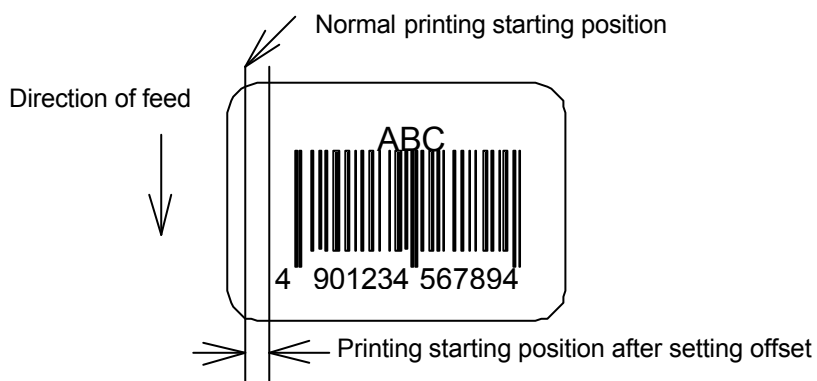

Setting number of cuts (2-digit)

Code c nn

Setting nn 00 - 99 Initialization value: 01

Function After printing specified number of labels, cuts paper.

Caution This command is invalid unless the auto -cutter is installed and it is turned to ON. Since the initialization value is 01 (one sheet), if the auto-cutter is ON, each label sheet will be cut automatically. When the label is cut by using the paper cut command (o), this must be set to 0 (zero) sheet.

Example Input data below represents that the same contents of the labels are printed ten sheets and cut out every two sheets.

Input data	[02] n	Sets units to inch
	[02] L	Starts label format mode
	D22	Sets pixel size
	Q0010	Sets 10 sheets for same label printing
	190000700500050ABC	Sets character data "ABC" with smooth font 24pt
	c 02	Sets 2 sheets for cutting
	E	Ends label format mode and prints

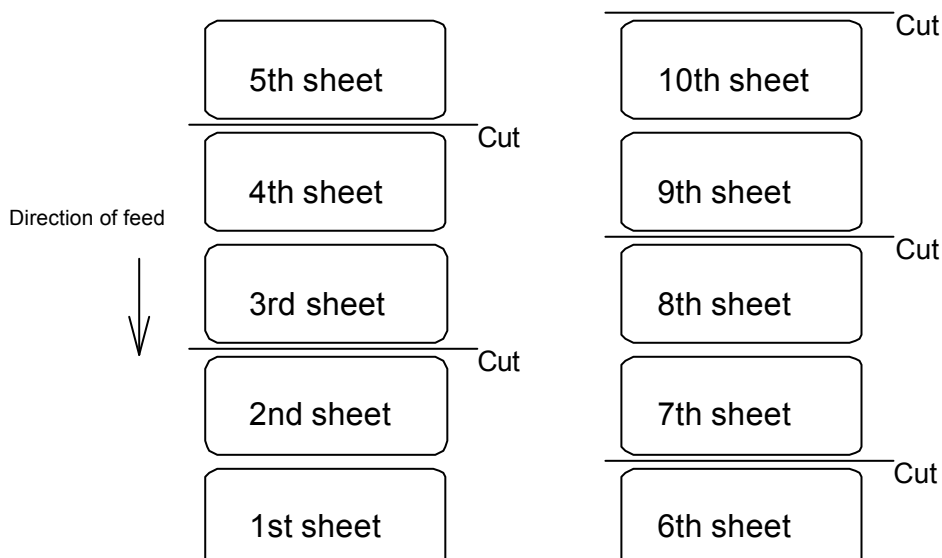

Setting pixel size in horizontal and vertical direction

Code	D hv
Units	One dot 0.127 mm or 0.005 inch
Setting	h Dot size in horizontal direction 1, 2 v Dot size in vertical direction 1, 2, 3

Note: Initialization value will be varied by the Print Res. DPI (DP mm) set by the operation panel.

Command Set	Initialization value
DMI / DMW	11
DM4 / DM8	22
DPP	11

Function Specifies pixel size (dot formation units) in the range of 1 dot x 1 dot to 2 dots x 3 dots. If dot size in vertical direction is doubled or tripled, the maximum printing length (printing range) will be doubled or tripled.

Example The following is that dot size in horizontal direction is set to 1 and dot size in vertical direction is set to 1.

Input data	[02] n	Sets units to inch
	[02] L	Starts label format mode
	D11	Sets pixel size
	1F33060005000050490123456789	Sets EAN13 bar code for data "490123456789"
	E	Ends label format mode and prints

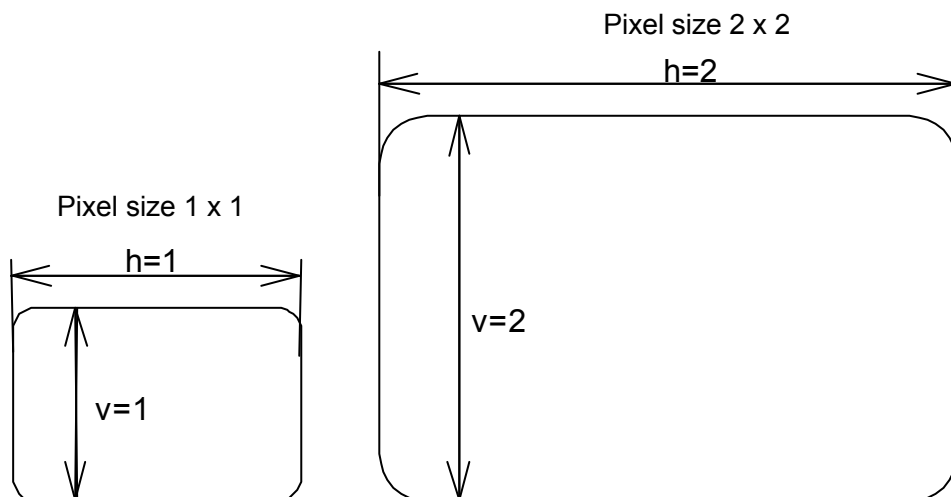

Completion of setting printing contents (field preparation) and printing labels

Code	E
Function	Completes printing contents setting and prints labels. On completion of printing, command interpreter is switched to system level interpreter and system level commands are valid.
Caution	If label format commands are used again, use the system level "STX" + "L" command.

Entering previous-defined field character string into global table

Code	G
Function	Enters a previous -defined label format character string into global table, allocating one character in alphabetical order from A to P. Reading of character string stored in the global table is executed with command "Reading out from global register "
Example	Input data below represents that data of character string "ABC" is stored in the global table with font 9 and fonts 9 and 5 are printed.
Input data	[02] n Sets units to inch [02] L Starts label format mode D22 Sets pixel size 190000500800120ABC Sets character data "ABC" with smooth font 14pt G Stores character string "ABC" in global table 151100002800120[02]SA E Ends label format mode and prints

Setting print density (head heat factor)

Code	H nn
Setting	nn 00 – 20 in DPP 00 – 30 in DM4/DM8/DMI/DMW Initialization value: 10
Function	Sets print density (heat energy is applied to print head).

Changing units from inch to metric system

Code	m
Function	Changes units temporarily for all-distance-specified-command-parameters from 0.01 inch to 0.1 mm.
Example	Input data below represents that data "ABC" is specified with units in metric system.

Changing units from metric to inch system

Code	n
Function	Changes units temporarily for all-distance-specified-command-parameters from 0.1 mm to 0.01 inch. Operation is same as [02] n command.

Setting printable area speed

Code P a

Setting a One alphanumeric character.
 A or B or 1 2 .0 inches (50.8 mm)/sec
 C or D or 2 2 .0 inches (50.8 mm)/sec
 E or F or 3 3 .0 inches (76.2 mm)/sec
 G or H or 4 4 .0 inches (101.6 mm)/sec
 I or J or 5 5 .0 inches (127.0 mm)/sec
 K or L or 6 6 .0 inches (152.4 mm)/sec
 M or N or 7 7 .0 inches (177.8 mm)/sec
 O or P or 8 8 .0 inches (203.2 mm)/sec
 Q or R or 9 9 .0 inches (228.6 mm)/sec
 S or T or a 10 .0 inches (254.0 mm)/sec
 U or V or b 11 .0 inches (279.4 mm)/sec
 W or c 12 .0 inches (304.5 mm)/sec

Note: Initial value and maximum value vary depending on the printer model.

Function Sets printable area speed.

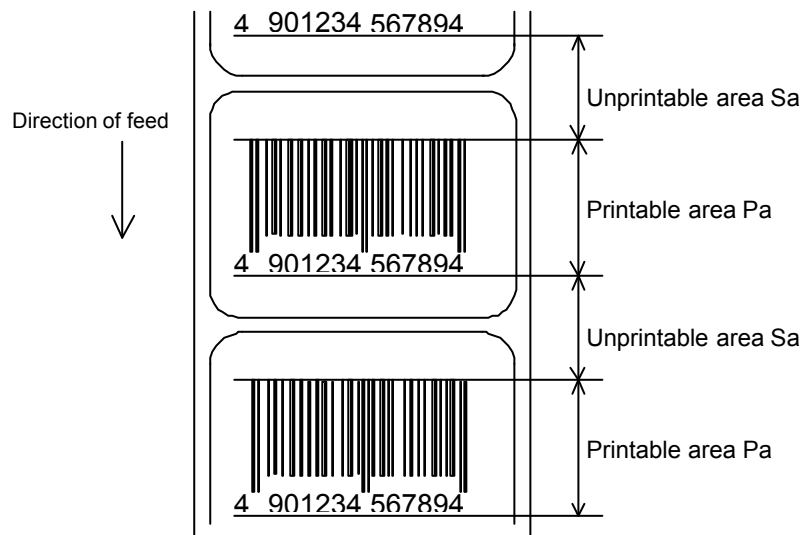

Setting backfeed speed

Code p a

Setting a One alphanumeric character.
A or B or 1 2 .0 inches (50.8 mm)/sec
C or D or 2 2 .0 inches (50.8 mm)/sec
E or F or 3 3 .0 inches (76.2 mm)/sec
G or H or 4 4 .0 inches (101.6 mm)/sec
I or J or 5 5 .0 inches (127.0 mm)/sec
K or L or 6 6 .0 inches (152.4 mm)/sec
M or N or 7 7 .0 inches (177.8 mm)/sec
O or P or 8 8 .0 inches (203.2 mm)/sec
Q or R or 9 9 .0 inches (228.6 mm)/sec
S or T or a 10 .0 inches (254.0 mm)/sec
U or V or b 11.0 inches (279.4 mm)/sec
W or c 12 .0 inches (304.5 mm)/sec

Note: Initial value and maximum value vary depending on the printer model.

Function Sets backfeed speed.

Specifying space between characters

Code [1b] P nn Data in [] is hex.

Setting nn Amount of space between characters 00 - 99
Initialization value: 00

Function Adds specified space between characters to all characters.

Example Input data below represents that data without specification of space between characters and data with specification of 10 to space between characters are set and printed.

Input data	[02] n	Sets units to inch
	[02] L	Starts label format mode
	D11	Sets pixel size
	190000700500050ABC	Sets character data "ABC" with smooth font 24pt
	[1b] P10	Sets 10 for space between characters
	190000700800050ABC	Sets character data "ABC" with smooth font 24pt
	E	Ends label format mode and prints

Spaces between characters nn=13

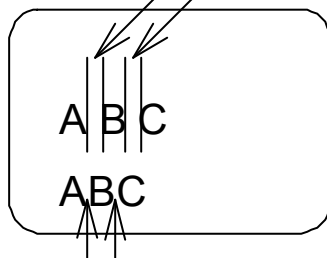

Spaces between characters nn=0

Setting number of prints

Code	Q nnnn	
Setting	nnnn 0001 – 9999	Initialization value : 0001
Function	Sets number of sheets to be printed.	
Example	Input data below represents that the same contents of labels are printed ten sheets.	
Input data	[02] n	Sets units to inch
	[02] L	Starts label format mode
	D11	Sets pixel size
	Q0010	Setting 10 sheets for same label printing
	1F3306000500050490123456789	Sets EAN13 bar code for data "490123456789"
	E	Ends label format mode and prints

Setting offset in direction of row

Code	R nnnn		
Units	0.01 inch or 0.1 mm		
Setting	nnnn	4-digit data	Initialization value: 0000
		Inch system	0000 - 9999 (0.00 inch - 99.99 inches)
		Metric system	0000 - 9999 (0.0 mm - 99.9 mm)
Function	Sets offset value for printing start position in direction of row (paper top and bottom) to adjust the position of the total printing contents.		
Example	Shifts label printing position 1.0 inch (R0100) upwards and prints.		
Input data	[02] n		Sets units to inch
	[02] L		Starts label format mode
	D11		Sets pixel size
	R0100		Sets row offset to 1.0 inch
	190000501150090ABC		Sets character data "AB C" with smooth font 14pt
	1F3306000500050490123456789		Sets EAN13 bar code for data "490123456789"
	E		Ends label format mode and prints

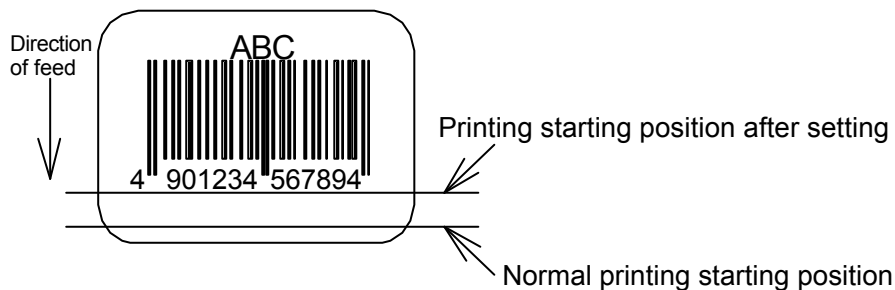

Calling label format

Code	r aa..a	
Setting	aa..a	Maximum 16 characters of format name ending with CR code
Function	Calls label format stored in the memory module. Storing of label format into memory module is executed with "s" command.	
Caution	Priority for calling module (1) Default (module C) or STX + Xa setting module (2) Modules other than above	
Example	Input data below represents that label format data is stored in the RAM by using "NAME" and label format is ended once, then put in again and file name "NAME" in the RAM is called and those data together with the current label format data are printed.	
Input data	[02] n	Sets units to inch
	[02] L	Starts label format mode
	D11	Sets pixel size
	190000700500050PRINTER	Sets data "PRINTER" with smooth font 24pt
	sNAME	Stores label format name "NAME" in on-board RAM and ends label format mode
	[02] L	Starts label format mode
	rNAME	Reads out label format "NAME" data
	D11	Sets pixel size
	190000700800050LABEL	Sets data "LABEL" with smooth font 24pt
	E	Ends label format mode and prints

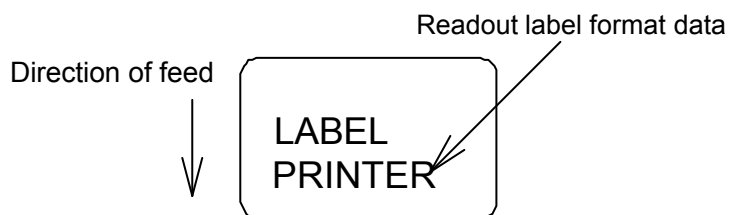

Setting unprintable area speed

Code S a

Setting a One alphanumeric character.

A or B or 1 2 .0 inches (50.8 mm)/sec

C or D or 2 2 .0 inches (50.8 mm)/sec

E or F or 3 3 .0 inches (76.2 mm)/sec

G or H or 4 4 .0 inches (101.6 mm)/sec

I or J or 5 5 .0 inches (127.0 mm)/sec

K or L or 6 6 .0 inches (152.4 mm)/sec

M or N or 7 7 .0 inches (177.8 mm)/sec

O or P or 8 8 .0 inches (203.2 mm)/sec

Q or R or 9 9 .0 inches (228.6 mm)/sec

S or T or a 10 .0 inches (254.0 mm)/sec

U or V or b 11 .0 inches (279.4 mm)/sec

W or c 12 .0 inches (304.5 mm)/sec

Note: Initial value and maximum value vary depending on the printer model.

Function Sets unprintable area speed.

Storing label format

Code s naa.aa

Setting n Memory module specification parameter A, B, C, D, E, F, G
Allocation of module varies with command settings.
Refer to the table below.

Allocation of module	Command Set		
	DMI / DMW	DM4 / DM8	DPP
on-board SD-RAM	D	A	B
on-board flash memory	G	B	A
PCMCIA Card (option)	E or F	E or F	E or F
Current memory module	on-board SD-RAM	on-board SD-RAM	on-board SD-RAM

aa..a Maximum 8 characters of format name ending with CR code

Function Stores label format into memory module and ends label format.

Caution This command is used differently depending on the command set. In other words, it is used differently depending on whether the command is designated at the end of the label format or designated at a given position within the label format. When designating it at a given position within the label format, label format ending command ("E" or "X") is required.

Refer to the table below for details.

Command Set	Designated position for storing label format
DMI / DMW	Designates at the end of label format (It is possible to omit the end command "E".)
DM4 / DM8	Designates at the end of label format (It is possible to omit the end command "E".)
DPP	Designates at a given position within label format (The end command "E" or "X" is required.)

Example Input data below represents that label format data is stored in the on-board memory by using format name "NAME."

Input data

[02] n	Sets units to inch
[02] L	Starts label format mode
D11	Sets pixel size
190000700500050PRINTER	Sets data "PRINTER" with smooth font 24pt
sANAME	Stores label format name "NAME" in on-board RAM and ends label format mode

Specifying ending code

Code	T nn	
Setting	nn Two characters of hex ASCII code Initialization value: CR[0D]	
Function	Specifies ending code, which is valid for field immediately after this command and after that field ending returns to default CR [0D].	
Example	The following shows that ending code uses NULL [00].	
Input data	[02] n	Sets units to inch
	[02] L [0D]	Starts label format mode
	D22	Sets pixel size
	T00 [0D]	Sets ending code to 'NULL [00]'
	190000500800120ABC [00]	Sets character data "ABC" with smooth font 14pt
	Q0002 [0D]	Sets 2-sheet-printing
	E	Ends label format mode and prints

Setting previous field to character-string-replacement-mode field

Code	U	
Function	Changes previous field to character -string-replacement-mode field, i.e., prepares replacement for only changing data. This command is not used when label is totally reconstructed.	
Caution	Register length is set according to the length of data for generating character string. Therefore, lengths of data for old and new character strings must be the same.	
Example	The following shows the use of character -string-replacement-mode field.	
Input data	[02] n	Sets units to inch
	[02] L [0D]	Starts label format mode
	D22	Sets pixel size
	161100000100060ABC	Sets character data "ABC" with system font 6
	161100001100060SUNDAY	Sets character data "SUNDAY" with system font 6
	U	Sets character-string-replacement-mode field
	X	Ends label format mode
	[02] U02MONDAY	Replaces character data "SUNDAY" with "MONDAY"
	[02] G	

Completion of setting printing contents (field preparation)

Code	X	
Function	Completes printing contents setting, switches command interpreter into system level interpreter, and system level command is valid.	
Caution	Printer waits for label format command input until it receives the commands such as E and X, so printer cannot advance to the next operation.	

TrueType font symbol set selection

Code	ySxx
Setting	S S fixed xx Selecting symbol set 2 digits characters followed by "CR" code to end. For the details, refer to explanation for [02] y command.
Function	Selection of a TrueType font symbol set
Caution	It depends on each TrueType font file for the symbol set which becomes actually effective.
Example	The following shows selection of Swedish symbol set:
Input data	[02] n Sets units to inch [02] L Starts label format mode D11 Sets pixel size YSSW Sets Swedish symbol set for TrueType font 1911S5000500050P024P024ABC Sets character data "ABC" of TrueType downloaded font E Ends label format mode and prints

Setting slash zero

Code	z
Function	Specifies numeric zero without slash. This setting is valid for system font 0 to 6.
Caution	This setting is valid within label format.
Example	Input data below represents that data "0001" is printed by specifying non-slash zero.
Input data	[02] n Sets units to inch [02] L Starts label format mode D22 Sets pixel size z Specifies non-slash zero 1600010000000500001 Sets data "0001" with system font 6 E Ends label format mode and prints

Setting addition of previous-defined printing contents (field data) 1

Code	+ pii..
Setting	p Specifies character (all ASCII characters available) for filling zero. ii Amount of addition (decimal)
Function	Adds field data that was defined before this command.
Example	Input data below represents that data "0001" is printed 5 sheets by using this command specifying 2 for the amount of addition.
Input data	[02] n Sets units to inch [02] L Starts label format mode D11 Sets pixel size 1900010000000500001 Sets data "0001" with smooth font 48pt +02 Amount of addition: +2 Q0005 Specifies 5-sheet printing E Ends label format mode and prints

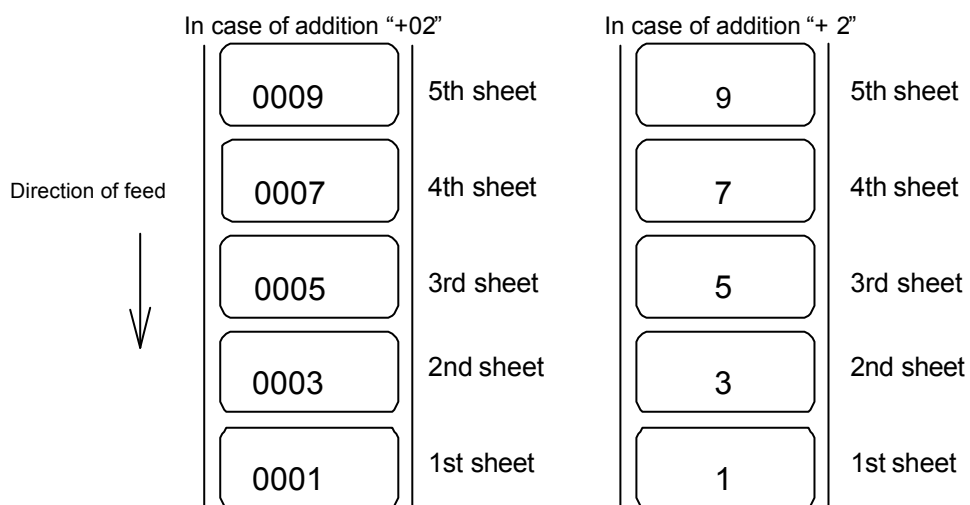

Setting subtraction of previous-defined printing contents (field data) 1

Code	- pii..
Setting	p Specifies character (all ASCII characters available) for filling zero. ii Amount of subtraction (decimal)
Function	Subtracts field data that was defined before this command.
Example	Input data below represents that data "1000" is printed 5 sheets by using this command specifying 2 for the amount of subtraction.
Input data	[02] n Sets units to inch [02] L Starts label format mode D11 Sets pixel size 19000100000000501000 Sets data "1000" with smooth font 48pt -010 Amount of subtraction: -10 Q0005 Specifies 5-sheet-printing E Ends label format mode and prints

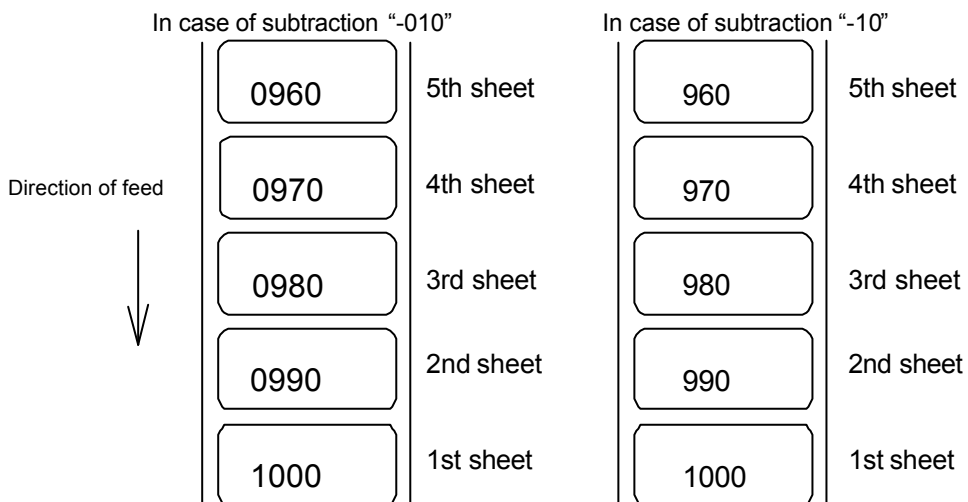

Setting addition of previous-defined printing contents (field data) 2

Code	> pii..	
Setting	p Specifies character (all ASCII characters available) for filling zero. ii Amount of addition (use of ASCII characters of A - Z prohibited)	
Function	Adds field data which was defined before this command by using base 36 system of 0 - 9, A - Z.	
Example	Input data below represents that data "1000" is printed 5 sheets by using this command specifying 5 for the amount of addition.	
Input data	[02] n	Sets units to inch
	[02] L	Starts label format mode
	D11	Sets pixel size
	1900010000000500001	Sets data "0001" with smooth font 48pt
	>05	Amount of addition: +5
	Q0005	Specifies 5-sheet-printing
	E	Ends label format mode and prints

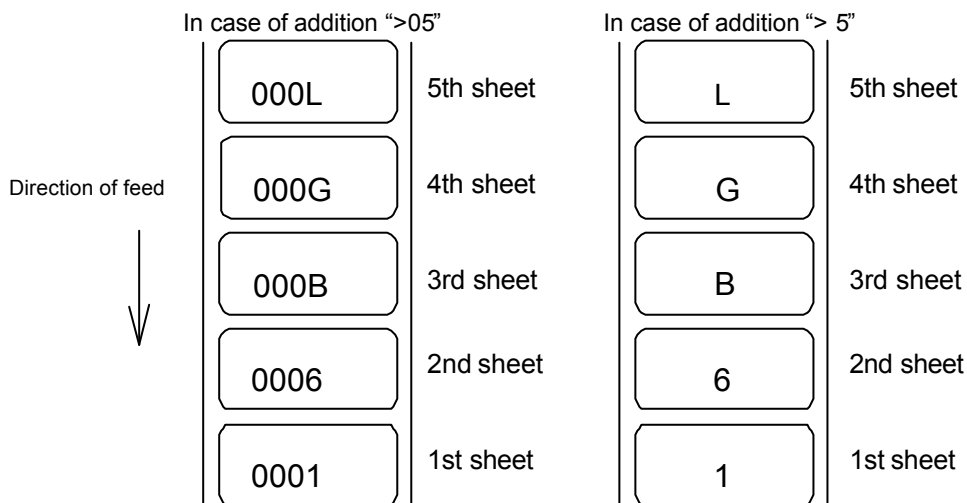

Setting subtraction of previous-defined printing contents (field data) 2

Code	< pii..	
Setting	p Specifies character (all ASCII characters available) for filling zero. ii Amount of subtraction (use of ASCII characters of A - Z prohibited)	
Function	Subtracts field data which was defined before this command by using base 36 system of 0 - 9, A - Z.	
Example	Input data below represents that data "1000" is printed 5 sheets by using this command while specifying 5 for the amount of subtraction.	
Input data	[02] n	Sets units to inch
	[02] L	Starts label format mode
	D11	Sets pixel size
	1900010000000501000	Sets data "1000" with smooth font 48pt
	<05	Amount of subtraction: -5
	Q0005	Specifies 5-sheet-printing
	E	Ends label format mode and prints

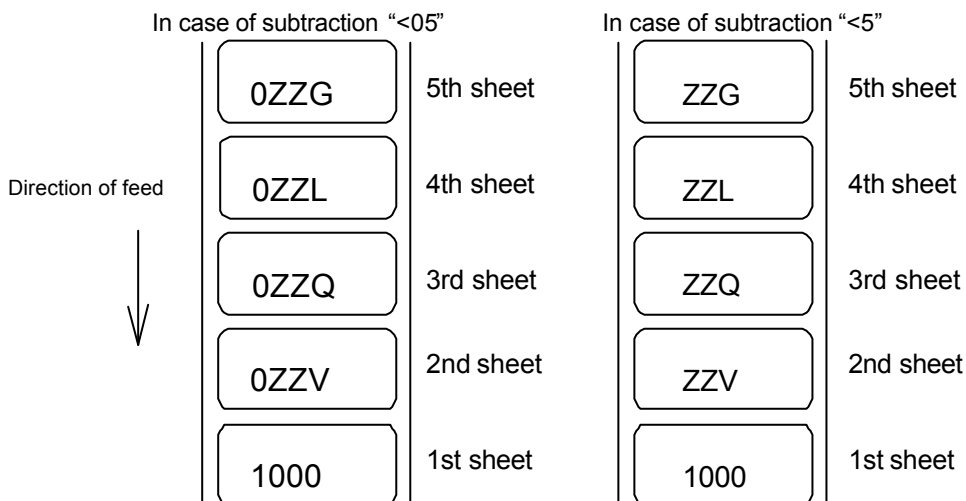

Setting number of prints for same label

Code	^ nn	
Setting	nn	2-digit numeric 01 - 99
Function	<p>Specifies number of prints for same label when addition and subtraction and time printing are specified.</p> <p>Executes addition, subtraction, etc. after printing number of sheets specified with nn.</p> <p>Specifies addition and subtraction per field, but if the number of prints for same labels is specified for one label, this specification will be effective to all fields.</p>	
Example	<p>Input data below represents that data "0001" is printed 5 sheets by using this command while specifying 2 for the amount of addition and 2 sheets of prints for same printing contents.</p>	
Input data	[02] n	Sets units to inch
	[02] L	Starts label format mode
	D11	Sets pixel size
	1900010000000500001	Sets data "0001" with smooth font 48pt
	+02	Amount of addition: +2
	^ 02	Sets 2 sheets for same printing contents
	Q0005	Specifies 5-sheet-printing
	E	Ends label format mode and prints

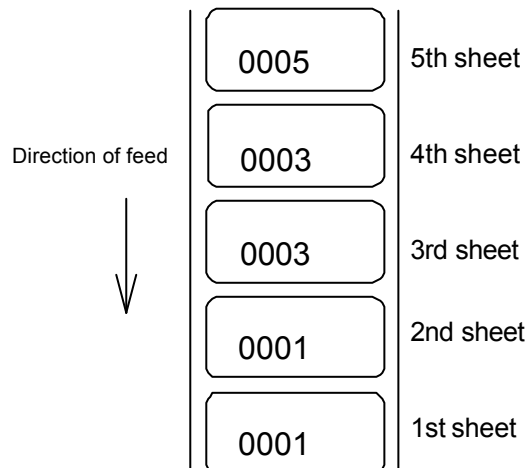

Setting number of cuts (4-digit)

Code	: nnnn	
Setting	nnnn 0001 - 9999	Initialization value: 0001
Function	Cuts paper after printing same labels by specified number.	
Caution	This command is invalid unless auto -cutter is mounted and cutter is set to ON.	
Example	Input data below represents that same labels are printed 10 sheets and cut every 2 sheets.	
Input data	[02] n	Sets units to inch
	[02] L	Starts label format mode
	D11	Sets pixel size
	Q0010	Sets 10 sheets for printing same labels
	1F3306000050050490123456789	Sets EAN13 bar code for data "490123456789"
	:0002	Sets 2 sheets for number of cuts
	E	Ends label format mode and prints

Character field definition

Code	rotate, font, hexp, vexp, point, row, column, d1, d2,.....
Setting	<p>rotate Sets rotation direction for character data 1, 2, 3, 4 1: 0° 2: 90° 3: 180° 4: 270°</p> <p>font Sets font , type of character (see table 1)</p> <p>hexp Sets expansion rate in horizontal direction 1 - 9, A - O (A - O corresponding to 10 - 24)</p> <p>vexp Sets expansion rate in vertical direction 1 - 9, A - O (A - O corresponding to 10 - 24)</p> <p>point Sets size of smooth font A06 – A72 (corresponding to 6pt - 72pt) Sets downloading font ID 100 - 999 (see table 2) Setting of this item is valid only when font is set to 9.</p> <p>row Row address 0000 - 9999 Unit: 0.01 inch</p> <p>column Column address 0000 - 0410 Unit: 0.01 inch</p> <p>d1, d2,.. Printing character data Character data ending with CR</p> <p>By setting [02] Sn (n is a calling character string parameter specifying A - P), character string data stored in the global register is picked out and printed.</p>

Function Prints characters for content data entered with items such as rotation, vertical and horizontal expansion rate, type of font and printing position.

Example Input data below represents that data "123" is printed with system font 6, vertical and horizontal expansion rate 1 and row and column address 0.5 inch, and data "ABC" is printed with smooth font 30pt and vertical and horizontal expansion rate row address 1.0 inch and column address 0.5 inch.

Input data	[02] n	Sets units to inch
	[02] L	Starts label format mode
	D22	Sets pixel size
	16 11 000 0050 0050 123	Sets data "123" with system font 6
	19 11 A30 0100 0050 ABC	Sets data "ABC" with smooth font 30pt
	E	Ends label format mode and prints

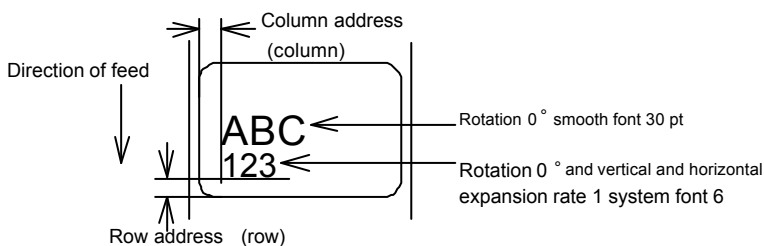

Table 1-A (203 dpi print head)

		Dot number			Pixel size horizontal (H) x vertical (V)			Units (mm)
Type of character	Font	H	Space	V	1 x 1	2 x 2	2 x 3	3 x 2 ^{*1}
System font	0	5	1	7	0.8 x 0.9	1.5 x 1.8	1.5 x 2.6	2.3 x 1.8
	1	7	2	13	1.1 x 1.6	2.3 x 3.3	2.3 x 4.9	3.4 x 3.3
	2	10	2	18	1.5 x 2.3	3.0 x 4.5	3.0 x 6.8	4.5 x 4.5
	3	14	2	27	2.0 x 3.4	4.0 x 6.8	4.0 x 10.1	6.0 x 6.8
	4	18	3	36	2.6 x 4.5	5.3 x 9.0	5.3 x 13.5	7.9 x 9.0
	5	18	3	52	2.6 x 6.5	5.3 x 13.0	5.3 x 19.5	7.9 x 13.0
	6	32	4	64	4.6 x 8.0	9.0 x 16.0	9.0 x 24.0	13.5 x 16.0
	7	15	5	32	2.5 x 4.0	5.0 x 8.0	5.0 x 12.0	7.5 x 8.0
	8	15	5	28	2.5 x 3.5	5.0 x 7.0	5.0 x 10.5	7.5 x 7.0

Table 1-B (300 dpi print head)

		Dot number			Pixel size horizontal (H) x vertical (V)			Units (mm)
Type of character	Font	H	Space	V	1 x 1	2 x 2	2 x 3	3 x 2 ^{*1}
System font	0	6	1	10	0.6 x 0.8	1.2 x 1.7	1.2 x 2.5	1.8 x 1.7
	1	10	3	18	1.1 x 1.5	2.2 x 3.0	2.2 x 4.6	3.3 x 3.0
	2	14	3	27	1.4 x 4.8	2.9 x 9.7	2.9 x 14.5	4.3 x 9.7
	3	18	3	36	1.8 x 3.0	3.6 x 6.1	3.6 x 9.1	5.3 x 6.1
	4	24	4	48	2.4 x 4.1	4.7 x 8.1	4.7 x 12.2	7.1 x 8.1
	5	24	4	72	2.4 x 6.1	4.7 x 12.2	4.7 x 18.3	7.1 x 12.2
	6	42	6	88	4.1 x 7.5	8.1 x 14.9	8.1 x 22.4	12.2 x 14.9
	7	22	7	46	2.5 x 2.7	4.9 x 5.4	4.9 x 8.1	7.4 x 5.4
	8	21	8	33	2.5 x 2.7	4.9 x 5.4	4.9 x 8.1	7.4 x 5.4

Note: *1 represents that character rotation direction is 90 and 270 deg.

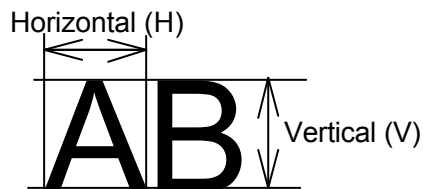

Table 2

Type of character	Font	Point or downloading ID	Point number	note	
Smooth font Triumvirate	9	A04	-	4pt	Available only with 300 DPI models
		A05	-	5pt	
		A06	001	6pt	
		A08	002	8pt	
		A10	003	10pt	
		A12	004	12pt	
		A14	005	14pt	
		A18	006	18pt	
		A24	007	24pt	
		A30	008	30pt	
		A36	009	36pt	
		A48	010	48pt	
A72	011	72pt			
Smooth font Triumvirate Bold	9	C04	-	4pt	Available only with 300 DPI models
		C05	-	5pt	
		C06	121	6pt	
		C08	122	8pt	
		C10	123	10pt	
		C12	124	12pt	
		C14	125	14pt	
		C18	126	18pt	
		C24	127	24pt	
		C30	128	30pt	
		C36	129	36pt	
		C48	130	48pt	
C72	131	72pt			
Downloading font	9	100 - 999			
TrueType Downloading font	9	S50 – S5z, S90 – S9z		In Binary code	
		s50 – s5z, s90 – s9z		In Hexadecimal code	
		U50 – U5z, U90 – U9z		For double-byte characters In Binary code	
		u50 – u5z, u90 – u9z		For double-byte characters In Hexadecimal code	

Type Font Character field definition

Code	rotate, font, hexp, vexp, id, row, column, height, width, d1, d2,.....	
Setting	rotate	Sets rotation direction for character data 1, 2, 3, 4 1: 0 ° 2: 90 ° 3: 180 ° 4: 270 °
	font	9 fixed
	hexp	Sets expansion rate in horizontal direction 1 - 9, A - O (A - O corresponding to 10 - 24)
	vexp	Sets expansion rate in vertical direction 1 - 9, A - O (A - O corresponding to 10 - 24)
	id	Download font ID Refer to table 2.
	row	Row address 0000 - 9999 Unit: 0.01 inch
	column	Column address 0000 - 0410 Unit: 0.01 inch
	height	Sets character height by a code of "P"+3 characters Number of dots set by unit of a dot.
	Width	Sets character width by a code of "P"+3 characters Number of dots set by unit of a dot.
	d1, d2,..	character data followed by "CR" code to end
Function	Downloaded TrueType font is printed in the print mode specified by this command.	
Example	Print the characters, "TrueType", in TrueType font (ID= 54) with 24 pt height and width.	
Input data	[02] n	Sets units to inch
	[02] L	Starts label format mode
	D11	Sets pixel size
	ySUK	Sets symbol set for UK.
	19 11 S54 0100 0100 P024 P024 TrueType	
	E	Ends label format mode and prints

Bar code field definition

Code	Rotate, font, thick, narrow, height, row, column, d1, d2,.....	
Setting	rotate	Sets rotation direction for bar code 1, 2, 3, 4 1: 0° 2: 90° 3: 180° 4: 270°
	Font	Sets type of bar code (see table 3)
	thick	Sets thick bar width in 1-dot units (0.005 inch) 1 - 9, A - O (A - O corresponding to 10 - 24)
	narrow	Sets narrow bar width in 1-dot units (0.005 inch) 1 - 9, A - O (A - O corresponding to 10 - 24)
	height	Sets height of bar code data by using 3-digit numeric 001 - 999 Unit: 0.0 1 inch
	row	Row address 0000 - 9999 Unit: 0.01 inch
	column	Column address 0000 - 0410 Unit: 0.01 inch
	d1, d2,..	Bar code data See table 3

Function Encodes contents data specified with items such as rotation, size of bar code data and printing position into bar code and prints.

Example Input data below is prepared with the following setting and printed.

font EAN-13
 bar ratio (thick : narrow) 3:3
 height 0.6 inch
 row, column 0.5 inch, 0.5 inch
 d1, d2,.. 490123456789

Input data	[02] n	Sets units to inch
	[02] L	Starts label format mode
	D11	Sets pixel size
	1F3306000500050490123456789	Sets EAN13 bar code for data "490123456789"
	E	Ends label format mode and prints

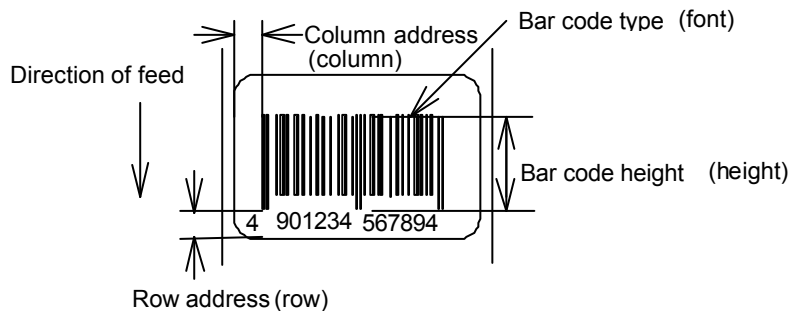

Table 3

Font	Bar code name		Bar ratio (thick:narrow)	No. of valid data
A	Code 3 of 9		3:1	Variable length
B	UPC-A		1:1, 2:2, 3:3, 4:4, 6:6, 8:8	12
C	UPC-E		1:1, 2:2, 3:3, 4:4, 6:6, 8:8	8
D	Interleaved 2 of 5		5:2	Even digit variable length
E	Code 128			Variable length
F	EAN-13 (JAN-13)		1:1, 2:2, 3:3, 4:4, 6:6, 8:8	13
G	EAN-8 (JAN-8)		1:1, 2:2, 3:3, 4:4, 6:6, 8:8	8
H	HIBC (Modulus 43-used Code 3 of 9)		3:1	Variable length
I	CODERBAR (NW-7)		3:1	Variable length
J	Int 2 of 5 (Modulus 10-used Interleaved 2 of 5)		5:2	Odd digit variable length
K	Plessey			Variable length
L	CASE CODE		5:2	14
M	UPC 2DIG ADD (UPC 2-digit supplementary code)			3
N	UPC 5DIG ADD (UPC 5-digit supplementary code)			6
O	Code 93		1:1, 2:2, 3:3, 4:4, 6:6, 8:8	Variable length
p	ZIP			Variable length
Q	UCC/EAN128		1:1, 2:2, 3:3, 4:4, 6:6, 8:8	19*
R	UCC/EAN128 (for K-MART)		1:1, 2:2, 3:3, 4:4, 6:6, 8:8	18*
S	UCC/EAN128 Random Weight		1:1, 2:2, 3:3, 4:4, 6:6, 8:8	34 or more*
T	Telepen			Variable length*
U / u	UPS MaxiCode			84 or less*
V	FIM			1*
Z / z	PDF417			Variable length
W1C/W1c	DataMatrix			Variable length
W1D/W1d	QR CODE			Variable length
W1F/W1f	Aztec			Variable length
ESC	Head of character string=q	QR CODE		Variable length
	Head of character string=M	Matrix 2 of 5	5:2	Variable length

(The number of valid data marked with asterisk is only used for input data length.)

Ruled line definition

Code	1X11, 000, row, column, Lhhhvvv or lhhhvwww	
Setting	1X11	1X11 fixed
	000	000 fixed
	row	row address 0000 - 9999
	column	column address 0000 - 0398
	L	Specifies line (3-digit)
	hhh	Specifies horizontal width
	v v v	Specifies vertical width
	l	Specifies line (4-digit)
	hhhh	Specifies horizontal width
	v v v v	Specifies vertical width
Units	0.01 inch	
Function	Prints ruled line with specified width. hhhh>vvvv designates horizontal line. hhhh<vvvv designates vertical line.	
Example	Input data below represents that ruled line with horizontal width of hhh 10 and vertical width of vvv 150 and ruled line with horizontal width of hhh 200 and vertical width of vvv 10 are printed.	
Input data	[02] n	Sets units to inch
	[02] L	Starts label format mode
	1X1100000500050L010150	Sets ruled line with 0.1 x 1.5 inch
	1X1100000500100L200010	Sets ruled line with 2.0 x 0.1 inch
	E	Ends label format mode and prints

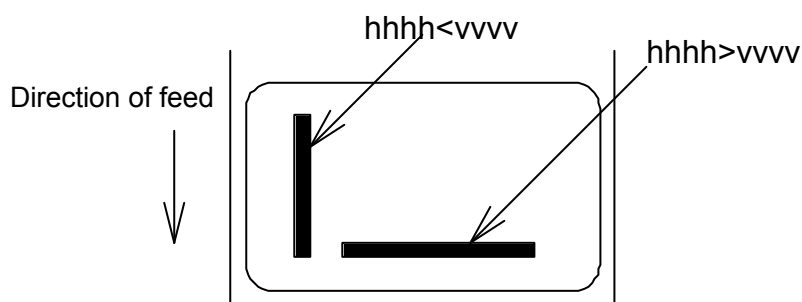

Box definition

Code 1X11, 000, row, column, Bhhhvvvbbbsss or bhhhhvvvvbbbbssss

Setting

1X11	1X11 fixed
000	000 fixed
row	row address 0000 - 9999
column	column address 0000 - 0410
B	Specifies box (3-digit)
hhh	Specifies horizontal width of box
v v v	Specifies vertical width of box
bbb	Specifies top and bottom line width
sss	Specifies left and right line width
b	Specifies box (4-digit)
hhhh	Specifies horizontal width of box
v v v v	Specifies vertical width of box
bbbb	Specifies top and bottom line width
ssss	Specifies left and right line width

Units 0.01 inch (0.1 mm)

Function Prints box with specified dimension.

Example Input data below represents that box with horizontal width of hhh 200, vertical width of vvv 100, upper and lower ruled line width of bbb 10 and both side line width of sss 3 is printed.

Input data

[02] n	Sets units to inch
[02] L	Starts label format mode
1X1100000500050B200100010003	Sets box with 2.0 (horizontal) x 1.0 (vertical) inch
E	Ends label format mode and prints

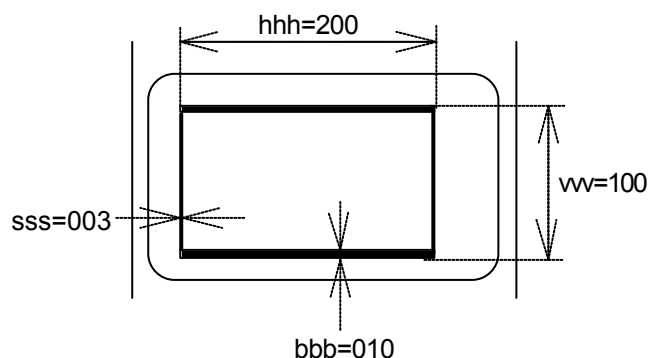

Graphics printing definition

Code	rotate, Y, hexp, vexp, 000, row, column, graphic	
Setting	rotate	Sets graphic data rotation direction to 1 (fixed)
	Y	Y fixed
	hexp	Sets expansion rate in horizontal direction 1 - 9, A - O (A - O corresponding to 10 - 24)
	vexp	Sets expansion rate in vertical direction 1 - 9, A - O (A - O corresponding to 10 - 24)
	000	000 fixed
	row	Row address 0000 - 9999
	column	Column address 0000 - 0398
	graphic	Specifies graphic file name to be printed
Function	Picks out file name from the memory module and prints.	
Caution	Graphic file to be printed with this command must be stored in the memory module.	
Example	Input data below represents that file name "IMAGE" in the memory module is printed.	
Input data	[02] n	Sets units to inch
	[02] L	Starts label format mode
	1Y1100000500050IMAGE	Sets graphic file name "IMAGE"
	E	Ends label format mode and prints

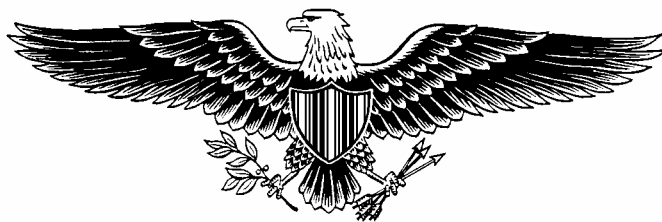

Polygon definition

Code 1X11, ppp, row, column, P ppp bbbb row, column, row, column

Setting 1X11 1X11 fixed
 ppp Dot pattern 000 – 011
 row 1st point row address 0000 – 9999
 column 1st point column address 0000 – 0398
 P Specifies polygon
 ppp 001 fixed
 bbbb 0001 fixed
 row 2nd point row address 0000 – 9999
 column 2nd point column address 0000 – 0398
 row 3rd point row address 0000 – 9999
 column 3rd point column address 0000 – 0398
 After this, repeats row and column

Units 0.01 inch (0.1 mm)

Function Draws polygon with specified point and dots inside with specified pattern.

Dot pattern 12 dot patterns from 0 – 11 are shown below.

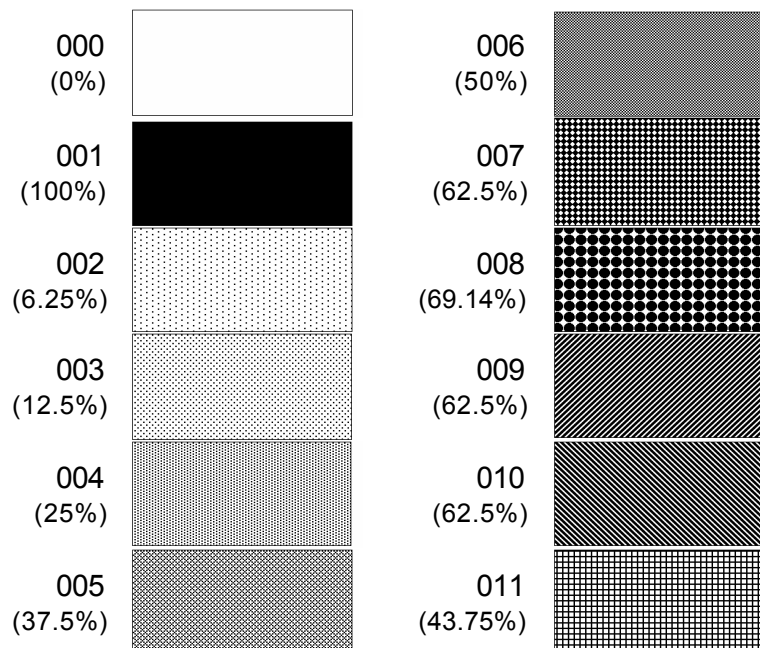

Example Input data below represents that triangle with three points, row 0.20 inch/column 0.10 inch, row 0.60 inch/column 0.30 inch, and row 0.20 inch/column 0.50 inch, is drawn and inside is dotted with pattern 6 (50% black).

Input data [02] n Sets units to inch
 [02] L Starts label format mode
 D11 Sets pixel size
 1X11 006 0020 0010 P 001 0001 0060 0030 0020 0050
 Sets polygon
 E Ends label format mode and prints

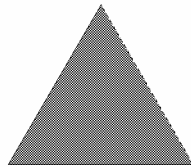

Example Input data below represents that rectangle with four points, row 0.20 inch/column 0.20 inch, row 0.40 inch/column 0.20 inch, row 0.40 inch/column 1.00 inch, and row 0.20 inch/column 1.00 inch, is drawn and inside is dotted with pattern 8 (little circle).

Input data [02] n Sets units to inch
 [02] L Starts label format mode
 D11 Sets pixel size
 1X11 008 0020 0020 P 001 0001 0040 0020 0040 0100 0020 0100
 Sets polygon
 E Ends label format mode and prints

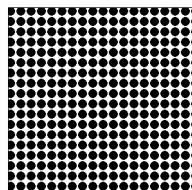

Circle definition

Code	1X11, ppp, row, column, C ppp bbbb, radius	
Setting	1X11	1X11 fixed
	ppp	Dot pattern 000 – 011
	row	Circle center row address 0000 – 9999
	column	Circle center column address 0000 – 0398
	C	Specifies circle
	ppp	001 fixed
	bbbb	0001 fixed
radius	Radius 0000 – 0398	
Units	0.01 inch	
Function	Draws circle with specified center and radius and dots inside with specified pattern.	
Example	Input data below represents that circle with center of row 0.50 inch/column 0.50 inch and radius of 0.30 inch is drawn and inside is dotted with pattern 10 (left diagonal lines).	
Input data	[02] n	Sets units to inch
	[02] L	Starts label format mode
	D11	Sets pixel size
	1X11 010 0050 0050 C 001 0001 0030	Sets circle
	E	Ends label format mode and prints

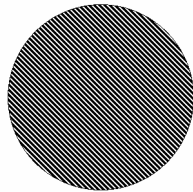

Reading out from global register

Code	rotate, font, hexp, vexp, point, row, column, [02], S, a
Setting	<p>rotate Sets rotation direction for character data 1, 2, 3, 4 1: 0° 2: 90° 3: 180° 4: 270°</p> <p>Font Sets type of character (see table 1)</p> <p>hexp Sets expansion rate in horizontal direction 1 - 9, A - O (A - O corresponding to 10 - 24)</p> <p>vexp Sets expansion rate in vertical direction 1 - 9, A - O (A - O corresponding to 10 - 24)</p> <p>point Sets size of smooth font</p> <p>CG Triumvirate: A06 - A72 (corresponding to 10 types of 6 to 72pt) Setting of this item is valid only when font is set to 9.</p> <p>row Row address 0000 - 9999 Unit: 0.01 inch</p> <p>column Column address 0000 - 0410 Unit: 0.01 inch</p> <p>[02] [02]hex fixed</p> <p>S Specifies reading out of global register</p> <p>a Specifies global register No. Alphabet (from A to P)</p>
Function	Reads out data stored in global register with G command.
Example	See sample No. 3 in Appendix 5.

Date and time printing definition

Code	rotate, font, hexp, vexp, point, row, column, [02], T, tdata...
Setting	<p>rotate Sets rotation direction for character data 1, 2, 3, 4 1: 0° 2: 90° 3: 180° 4: 270°</p> <p>Font Sets type of character (see table 1)</p> <p>hexp Sets expansion rate in horizontal direction 1 - 9, A - O (A - O corresponding to 10 - 24)</p> <p>vexp Sets expansion rate in vertical direction 1 - 9, A - O (A - O corresponding to 10 - 24)</p> <p>point Sets size of smooth font A06 - A72 (corresponding to 6 to 72pt) Setting of this item is valid only when font is set to 9.</p> <p>row Row address 0000 - 9999 Unit: 0.01 inch</p> <p>column Column address 0000 - 0410 Unit: 0.01 inch</p> <p>[02] [02]hex fixed</p> <p>T Specifies writing of time data</p> <p>tdata... Specifies date and time printing format by using the following alphabet and spaces</p> <p>A 1-digit day of week 0 -6 (Sunday to Saturday)</p> <p>BCD Name of day of the week Monday (MON)</p> <p>EF 2-digit month number 1 - 12 (January to December)</p> <p>GHI...NO Name of the month January (JANUARY)</p> <p>PQ 2-digit date 15 (day of 15)</p> <p>RSTU 4-digit year number 1995 (year of 1995)</p> <p>VW 2-digit time 24 -hour display</p> <p>XY 2-digit time 12 -hour display</p> <p>Za 2-digit minute 50 (minute of 50)</p> <p>bc Morning, Afternoon AM (Morning), PM (Afternoon)</p>
Function	Reads out and prints date and time in the calendar of the printer according to the specified format with this command.
Example	Input data below represents that date and time with specified format of name of day of the week (BCD), name of the month (GHI), date (PQ) and year number (RSTU) are printed.

Input data	[02] n	Sets units to inch
	[02] L	Starts label format mode
	D11	Sets pixel size
	190000500500050[02]TBCD GHI PQ, RSTU	Sets day of the week, month, date and year number
	E	Ends label format mode and prints

Chapter 2

Fonts and Bar Codes

2.1 Description of Fonts	2-2
2.2 Description of Bar Codes	2-8

Fonts and bar codes for this printer are listed below. Each name is expressed in numeric for fonts and in alphabetic characters for bar codes. Visible or non-visible code is identified with upper-case or lower-case alphabetic characters for the bar code name. Upper-case characters allow printer to print visible code bar code, while lower-case characters allow printer to print non-visible code bar code.

2.1 Description of Fonts

The following print sample is printed with pixel size of 1 dot x 1 dot, and the dot pattern in horizontal and vertical direction is printed with 1 time.

Font 0: Upper- and lower-case alphanumeric characters.

Character size:

203 dpi: 7 dots (height) x 5 dots (width) x 1 dot (space)

300 dpi: 10 dots (height) x 6 dots (width) x 1 dots (space)

```
!"#$%&'()*+,-./
0123456789:;<=>?
@ABCDEFGHIJKLMNO
PQRSTUVWXYZ[\]^_
`abcdefgijklmno
pqrstuvwxyz{|}~
ÇüéàâäåçèéëïíîË
ÈéÊËÖöÜüÛÜøŁ×ƒ
á í ó ù ñ Ñ ã ä å ö ø Ł × ƒ
c ¥ ß
```

Font 1: Upper- and lower-case alphanumeric characters.

Character size:

203 dpi: 13 dots (height) x 7 dots (width) x 2 dots (space)

300 dpi: 18 dots (height) x 10 dots (width) x 3 dots (space)

```
!"#$%&'()*+,-./
0123456789:;<=>?
@ABCDEFGHIJKLMNO
PQRSTUVWXYZ[\]^_
`abcdefgijklmno
pqrstuvwxyz{|}~
ÇüéàâäåçèéëïíîË
ÈéÊËÖöÜüÛÜøŁ×ƒ
á í ó ù ñ Ñ ã ä å ö ø Ł × ƒ
c ¥ ß
```

Font 2: Upper- and lower-case alphanumeric characters.

Character size:

203 dpi: 18 dots (height) x 10 dots (width) x 2 dots (space)

300 dpi: 27 dots (height) x 14 dots (width) x 4 dots (space)

```
!"#$%&'()*+,-./
0123456789:;<=>?
@ABCDEFGHIJKLMNO
PQRSTUVWXYZ[\]^_
`abcdefghijklmno
pqrstuvwxyz{|}~
ÇùéääåçèëèïìÏÄ
ÉæÆöòóôÛüÿÖø&Ø×f
áíóúñÑªª¸®¬¼¼¡«»
c¥ ß
```

Font 3: Upper- and lower-case alphanumeric characters.

Character size:

203 dpi: 27 dots (height) x 14 dots (width) x 2 dots (space)

300 dpi: 36 dots (height) x 18 dots (width) x 3 dots (space)

```
!"#$%&'()*+,-./
0123456789:;<=>?
@ABCDEFGHIJKLMNO
PQRSTUVWXYZ[\]^_
`abcdefghijklmno
pqrstuvwxyz{|}~
ÇùéääåçèëèïìÏÄ
ÉæÆöòóôÛüÿÖø&Ø×f
áíóúñÑªª¸®¬¼¼¡«»
c¥ ß
```

Font 4: Upper- and lower-case alphanumeric characters.

Character size:

203 dpi: 36 dots (height) x 18 dots (width) x 3 dots (space)

300 dpi: 48 dots (height) x 24 dots (width) x 4 dots (space)

!"#\$%&'()*+,-./
0123456789:;<=>?
@ABCDEFGHIJKLMNO
PQRSTUVWXYZ[\]^_
`abcdefghijklmno
pqrstuvwxyz{|}~
ÇüéâäååçêëèìîïÄÅ
ÉæÀôöòùÿÖÜø&Ø×f
áíóúñÑªº¿[®]-½¼¡«»
ϕ¥ β

Font 5: Upper- and lower-case alphanumeric characters.

Character size:

203 dpi: 52 dots (height) x 18 dots (width) x 3 dots (space)

300 dpi: 72 dots (height) x 24 dots (width) x 4 dots (space)

!"#\$%&'()*+,-./
0123456789:;<=>?
@ABCDEFGHIJKLMNO
PQRSTUVWXYZ[\]^_
`abcdefghijklmno
pqrstuvwxyz{|}~
ÇüéâäååçêëèìîïÄÅ
ÉæÀôöòùÿÖÜø&Ø×f
áíóúñÑªº¿[®]-½¼¡«»
ϕ¥ β

Font 6: Upper- and lower-case alphanumeric characters.

Character size:

203 dpi: 64 dots (height) x 32 dots (width) x 4 dots (space)

300 dpi: 88 dots (height) x 42 dots (width) x 6 dots (space)

!"#\$%&'()*+,-./
0123456789:;<=>?
@ABCDEFGHIJKLMNO
PQRSTUVWXYZ[\]^_
`abcdefghijklmnop
qrstuvwxyz{|}~
ÇüéâäàåçêëèïîìÄÅ
ÉæŁôöòûùÿÖÜø&Øxf
á í ó ú ñ Ñ^ª ^º ¿[®] ¬ ½ ¼ ¡ « »
¢ ¥ β

Font 7: Upper-case alphabetic characters and numeric OCR -A font.

Character size:

203 dpi: 32 dots (height) x 15 dots (width) x 5 dots (space)

300 dpi: 46 dots (height) x 22 dots (width) x 7 dots (space)

!"#\$%&'()*+,-./
0123456789:;<=>?
@ABCDEFGHIJKLMNO
PQRSTUVWXYZ[\]^_`
abcdefghijklmnop
qrstuvwxyz{|}~

Font 8: Upper- and lower-case alphabetic characters and numeric CR -B font.
Character size:

203 dpi: 28 dots (height) x 15 dots (width) x 5 dots (space)

300 dpi: 33 dots (height) x 21 dots (width) x 8 dots (space)

!"#\$%&'()*+,-./
0123456789:;<=>?
@ABCDEFGHIJKLMNO
PQRSTUVWXYZ[\]^_
`abcdefghijklmno
pqrstuvwxyz{|}

Font 9: Upper- and lower-case alphabetic characters, numeric and extension font (CG Triumvirate smooth font). Character size is any of 6, 8, 10, 12, 14, 18, 24, 30, 36, 48 or 72 points.

6 pt ABCDEFGHIJKLMNOPQRSTUVWXYZabcdefghijklmnopqrstuvwxyz0123456789

8 pt ABCDEFGHIJKLNOPQRSTUVWXYZabcdefghijklmnopqrstuvwxyz012345

10 pt ABCDEFGHIJKLMNOPQRSTUVWXYZabcdefghijklmnopqrstuvwxyz

12 pt ABCDEFGHIJKLMNOPQRSTUVWXYZabcdefghijklmnopqrstuvwxyz

14 pt ABCDEFGHIJKLMNOPQRSTUVWXYZ

18 pt ABCDEFGHIJKLMNOPQRST

24 pt ABCDEFGHIJKLMN

30 pt ABCDEFGHIJK

36 pt ABCDEFG

48 pt ABCDE

ABCDEFGHIJKLMNOPQRSTUVWXYZ
XYZ0123456789abcdefghijklmnopqrstuvwxyz
!"#\$%&'()*+,-./012345
6789:;<=>?@[^\]^_`{|}~Çüéääå
èïïÄÅÉæÆôöòûùÿÖÜø£Ø × f áíóúñ
®½¼¡ÁÂÀ©¢¥ãÃðÐÊËÈÌÍÎÏßÔÕö
μρϑÚÛÜÝ ± ¾ ÷ , ° °.

2.2 Description of Bar Codes

The following print sample is printed with a pixel size of 1 dot x 1 dot. The dot pattern in horizontal and vertical direction is printed with 1 time.

Bar code A: Code 3 of 9

This bar code consists of upper -case alphanumeric characters. Number of digits is variable in length. Start/stop codes " *" are given automatically by printer. Valid ASCII codes are as follows: 32, 36 -37, 43, 45-47, 48-57, 65-90. Standard ratio (ratio of thick bar to thin bar) of Code 3 of 9 is 3: 1.



Bar code B: UPC-A

This bar code consists of only numeric characters and is 12-digit fixed length. The 11 -digit numerics are input from the computer or applications software and the 12th digit is a checksum that is calculated automatically by the printer.

When the computer sends the 12th digit numeric, the printer compares the characters with the calculated checksum. If they do not agree, the printer prints all bar codes 0 (zero).

If supplementary code is to be added, refer to item of bar code M and N. Element size is 1 : 1, 2 : 2, 3 : 3, 4 : 4, 6 : 6, and 8 : 8.



Bar code C: UPC-E

This bar code consists of only numeric characters and is 8 -digit fixed length. The first digit numbering system character is "0" fixed so it is not transmitted. The 6th or 7th digit numeric excluding numbering system character is sent by the computer or applications software. (Transmit UPC-A shortening code.) The printer automatically calculates the checksum at the end of digit (8th). When the computer transmits the 8th digit numeric, the printer compares the characters with the calculated checksum. If they do not agree, the printer prints all bar codes 0. If supplementary code is to be added, refer to item of bar code M and N. Element size is 1 : 1, 2 : 2, 3 : 3, 4 : 4, 6 : 6, and 8 : 8.



Bar code D: Interleaved 2 of 5

This bar code consists of only numeric characters and even digits are variable in length. When an odd digit code is transmitted, the printer automatically adds one digit with 0 to the top of the transmission code to convert the number of digits to an even number. Valid ASCII code is 48-57. Standard ratio (ratio of thick bar to thin bar) is 5 : 2.



Bar code E: Code 128

This bar code consists of the full ASCII set of 128 characters and number of digits is variable in length. Checksum is performed through the modulus 103 calculation and added to the end of digit. This printer supports code subsets A, B and C. When one character of either A, B, or C is added to the top of the transmission code, the printer selects the starting order of the code subset. When neither A, B, nor C is added to the top of the transmission code, code subset B is selected.

Code subset A is a bar code which consists of standard upper -case alphabetic characters, numerics, keyboard characters, control characters and special characters. To select code subset A, data must be coded beforehand in ASCII code A (65 decimal, 41 hex).

Code subset B is a bar code which consists of standard upper - and lower-case alphabetic characters, numerics, keyboard characters, control characters and special characters. To select code subset B, data must be coded beforehand in ASCII code B (66 decimal, 42 hex).

Code subset C is a bar code that consists of special characters and 2 digits from 00 to 99. The numeric digit number gets coded twice. To select code subset C, data must be coded beforehand in ASCII code C (67 decimal, 43 hex). When code subset C is selected, the alphabetic characters should not be coded.

Special character processing

Characters of code number 96 or more are special characters. To input these characters, the 2 -character input reference table is shown below.

Code	2 characters	Code subset A	Code subset B	Code subset C
96	&A	FNC3	FNC3	- NA -
97	&B	FNC2	FNC2	- NA -
98	&C	SHIFT	SHIFT	- NA -
99	&D	CODEC	CODEC	- NA -
100	&E	CODEB	FNC4	CODEB
101	&F	FNC4	CODEA	CODEA
102	&G	FNC1	FNC1	FNC1

As an example of special character processing, code subset selection is provided:

<Code subset selection>

First select: Either 1-character entry of A, B, or C

Switch in midway: 2-character entry such as &D, &F

[Example] The TEST bar code is first printed with code subset B, and then 123 bar code with code subset A. Data is transmitted in the order of B, TEST, 2-character &F, and 123.

Input code: BTEST&F123

Bar code data: <CODEB>TEST<CODEA>123

Control code

Control characters are coded into code subset A. See the character input reference table below.

Control code	Input character	Control code	Input character	Control code	Input character
NUL	`	VT	k	SYN	v
SOH	a	FF	l	ETB	w
STX	b	CR	m	CAN	x
ETX	c	SO	n	EM	y
EOT	d	SI	o	SUB	z
ENQ	e	DLE	p	ESC	{
ACK	f	DC1	q	FS	
BEL	g	DC2	r	GS	}
BS	h	DC3	s	RS	~
HT	i	DC4	t	US	DEL
LF	j	NAK	u		



Bar code F: EAN-13 (JAN-13)

This bar code consists of only numeric characters and is 13-digit fixed length. The 12 -digit numerics are input from the computer or applications software and the 13th digit is a checksum automatically calculated by the printer. When the computer sends the 13th digit numeric, the printer compares the characters with the calculated checksum. If they do not agree, the printer prints all bar codes 0 (zero). If supplementary code is to be added, refer to item of bar code M and N. Element size is 1 : 1, 2 : 2, 3 : 3, 4 : 4, 6 : 6, and 8 : 8.



Bar code G: EAN-8 (JAN-8)

This bar code consists of only numeric characters and is 8-digit fixed length. The 7-digit numerics are input from the computer or applications software and the 8th digit is a checksum automatically calculated by the printer. When the 8th digit numeric is sent from the computer, the printer compares the characters with the calculated checksum. If they do not agree, the printer prints all bar codes 0 (zero). If supplementary code is to be added, refer to item of bar code M and N. Element size is 1 : 1, 2 : 2, 3 : 3, 4 : 4, 6 : 6, and 8 : 8.



Bar code H: HIBC

This is a bar code of the Code 3 of 9 HIBC (modulus 43 checksum) version and consists of upper -case alphanumeric characters. Number of digits is variable in length. Checksum is added to the end of data. To specify the type of data form at, enter "+" in the top of data. Start/stop codes "*" are automatically added by the printer. Valid ASCII codes are as follows: 32, 36 -37, 43, 45 -47, 48-57, 65-90. The standard HIBC ratio (ratio of thick bar to thin bar) is 3 : 1, as same as Code 3 of 9.



Bar code I: CODABAR

Basically, this code consists of only numeric characters and number of digits is variable in length. Valid codes are "0123456789 ABCD\$+-. / :." Standard ratio is 3 : 1. This bar code needs start/stop codes so either of A, B, C, or D must be added to the transmission code.



Bar code J: Interleaved 2 of 5 W/BARS

This is a bar code of the Interleaved 2 of 5 modulus 10 checksum and even digits including checksum are variable in length. Basically, code must be transmitted in an odd digit. The printer automatically calculates the data and adds the checksum to the end of transmission code. When even digit code is transmitted, the printer automatically adds 0 (zero) to the top of data. Valid ASCII code is 48 -57. Standard ratio is 5 : 2.



Bar code K: PLESSEY

This bar code consists of only numeric characters and number of digits is variable in length. Checksum is added to the end of digit through the modulus 10 calculation.



Bar code L: CASE CODE

This is a case code of the Interleaved 2 of 5 modulus 10 checksum and is 14-digit fixed length. Valid ASCII code is 48 -57. Standard ratio is 5 : 2.



Bar code M: UPC 2DIG ADD

This is a supplementary code of 2 digits for UPC and consists of only numeric characters and is 3-digit fixed length. The 2-digit numerics are input from the computer or applications software and the 3rd digit is a checksum automatically calculated by the printer. When the 3rd digit numeric is sent from the computer, the printer compares the characters with the calculated checksum. If they do not agree, the printer prints all bar codes 0 (zero).



Bar code N: UPC 5DIG ADD

This is a supplementary code of 5 digits for UPC and consists of only numeric characters and is 6-digit fixed length. The 5 -digit numerics are input from the computer or applications software and the 6th digit is a checksum automatically calculated by the printer. If the 6th digit numeric is sent from the computer, the printer compares the characters with the calculated checksum. If they do not agree, the printer prints all bar codes 0 (zero).

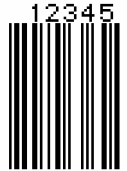

Bar code O: Code 93

This bar code consists of alphanumeric characters and number of digits is variable in length. Valid ASCII codes are "., & # @ \$ % ? + - . / ABCDEFGHIJKLMNOPQRSTUVWXYZ0123456789abcdefghijklmnopqrstuvwxyz." Element size is 1 : 1, 2 : 2, 3 : 3, 4 : 4, 6 : 6, and 8 : 8.



Bar code p: ZIP

This bar code consists of only numeric characters and number of digits is variable in length. Checksum is added to the end of data. The width and height of bar code is specified as same as fonts. Only lower-case characters are valid for setting bar code types.



Bar code Q: UCC/EAN-128

Number of digits is fixed in length and data is input with 19 numerics. Ratio depends on the value of thin bar. -digit

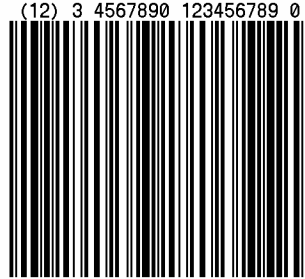

Bar code R: UCC/EAN-128 (for K-MART)

Number of digits is fixed in length and data is input with 18 numerics. Ratio depends on the value of thin bar. -digit

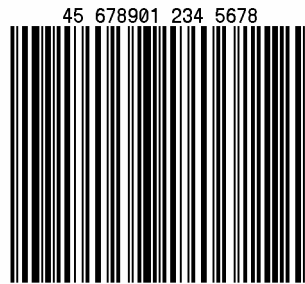

Bar code S: UCC/EAN-128 Random Weight

Number of digits is fixed in length and data is input with at least 34-digit numerics. Ratio depends on the value of thin bar.

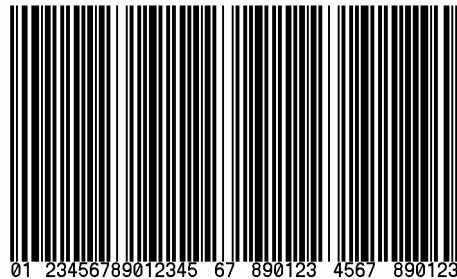

Bar code T: Telepen

Number of digits is fixed in length. Ratio depends on the value of thin bar.

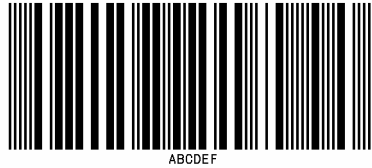

Bar code U / u: UPS MaxiCode

This bar code consists of alphanumeric characters and number is digits variable in length.

Barcode font type

U :Data amount should be set by 4 -digit bytes

u :Data amount is automatically set.

Input data consists of the following six elements:

4-digit-- Amount of data

Amount of data to be used when U is

Bytes following this value should be specified.

(Including 15 bytes for Zip code and nationality code and service code.)

When u is specified, the field is blank.

5-digit-- Zip code

4-digit --+4 Zip code

3-digit-- nationality code

3-digit-- class of service code

84 -digit or less data character string

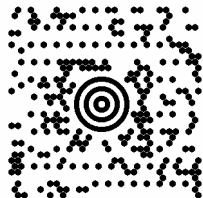

Bar code v: FIM

This bar code consists of alphabet A, B, C, and D and number of digits is fixed in length. The width and height of bar code is specified as same as fonts. Only lower-case characters are valid for setting bar code types.

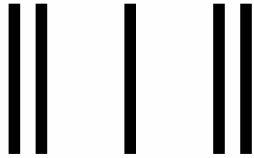

Bar code Z / z: PDF-417

This is a two-dimensional bar code and variable in length.

Barcode font type

Z :Data amount should be set by 4 -digit bytes

z :Data amount is automatically set.

Input data consists of the following seven elements:

4-digit--	Amount of data to be used when U is Bytes following this value should be specified. (Including 8 bytes for Truncate flag and Security level and Ratio and Height and Width.) When z is specified, the field is blank.
1-digit--	Truncate flag: T (omission type) or F (standard type)
1-digit--	Security level: 0 - 8
2-digit--	Ratio (numerator 1st digit and denominator 2nd digit in fraction): 00 - 99 Default: 00 (ratio of 1: 3)
2-digit--	Height: 03 - 90 Default: 00
2-digit--	Width: 01 - 30 Default: 00
Variable in length	Data character string



Bar code W1D / W1d or ESC enhancing + q: QR Code

This is two-dimensional bar code and has variable length.

When this code is generated, QR code information such as error correction level, mask number, data input modes and data, is specified. Available data input modes are manual setting mode in which a character mode is selected manually, and automatic setting mode in which character modes are switched automatically. Data divided into multiple QR codes can be concatenated. In order to concatenate such divided QR codes, Bound data (Bound mode identifier, code number, number of divisions and parity data) should be placed before QR information.

Depending on the bar code type, some parts of the specification method are different as seen in the model selecting method.

Specification of the bar code types

ESC extension : For both manual setting mode and automatic setting mode

W1D : For manual setting mode

W1d : For automatic setting mode

(Model 2, Error correction standard level and alphanumeric mode are fixed.)

The following parameters should be set after a bar code type is specified.

Selection of models

QR codes have two types as shown below and either of them is selected and used.

Model 1: Original specification

Model 2: Specification of extended function of improving position correction and handling large-capacity data

Model selecting methods

- At the time of ESC extension + q specification

Select a model at the position for setting a bar code height in the bar code field (3-digit number setting)

Set value (3-digit number)

Other than 002 --- Select Model 1

002 --- Select Model 2

- When W1D is specified

Select a model at the head of the file format.

Note: Some of the firmware is not compatible with Model 2. In this case, specification for the model 1 is always used no matter what model is selected.

In the case of normal mode

QR code formats vary depending on the bar code type.

Bar code type: ESC extension +q

In the case of automatic data setting

File format:

<Error correction level><Mask number><Data input mode ("A")>,
<Data character string>[End code]

In the case of manual data setting

File format:

<Error correction level><Mask number><Data input mode("M")>,
<Character mode 1><Data character string 1>,
<Character mode 2><Data character string 2>,
< : >< : >,
<Character mode n><Data character string n>,
[End code]

Bar code type: W1D (Data manual setting)

File format:

<Model selection method> <Error correction level ><Mask
number><Data input mode ("M")>,
<Character mode 1><Data character string 1>,
<Character mode 2><Data character string 2>,
< : >< : >,
<Character mode n><Data character string n>,
[End code]

Bar code type: W1d (Automatic data setting)

File format:

<Data character string >[End code]

File format parameter

Model selection method <1|2>

None --- When specifying a bar code other than W1D

1 --- Model 1

2 --- Model 2

Error correction level <H|Q|M|L>

H ---- Ultra high reliability level (Level H)

Q ---- High reliability level (Level Q)

M ---- Standard level (Level M)

L ---- High density level (Level L)

Mask number <0 to 7,8>

None --- Automatic selection

0 to 7 --- Mask 0 to 7

8 --- No mask

Data input mode <A|M>

A ---- Automatic setting (Default)

Data character string (JIS 8 bit characters, Shift JIS)

M ---- Manual setting

Character mode <N|A|B|K>

N --- Number

A --- Alphanumeric characters (Default)

B --- Binary

K --- Chinese characters

Data character string

Binary mode --- Amount of data + Data

(The data amount is 2 bytes and expressed using BCD codes)

Other modes --- Data

Example 1 :

Model :Functionality expansion specification (2)
 Level :Ultra high reliability level (H)
 Mask :Mask number 0 (0)
 Input mode :Manual setting (M)
 Mode :Numeric mode (N)
 Data :Description in generating QR codes using 0123456789012345
 Bar code type: ESC extension +q
 1[ESC] 4400200100010qH0M, N0123456789012345 [End code]
 Bar code type: W1D
 1W1D44000001000102H0M, N0123456789012345 [End code]

Example 2 :

Model : Original specification (1)
 Level : High reliability level (Q)
 Mask : Mask number 0 (0)
 Input mode : Manual setting (M)
 Mode : Alphanumeric mode (A)
 Data : Description in generating QR code using AC-42

Bar code type: ESC extension +q
 1[ESC] 4400000100010qQ0M,AAC-42 [End code]
 Bar code type: W1D
 1W1D44000001000101Q0M,AAC-42 [End code]

In the case of bound function

Bar code type: ESC extension +q
 In the case of automatic data setting
 File format:
 <Bound mode identifier ("D")><Code number><Number of divisions><Parity data>,
 <Error correction level><Mask number>
 <Data input mode ("A")>,<Data character string> [End code]

In the case of data manual setting
 File format:
 <Bound mode identifier ("D")><Code number>
 <Number of divisions><Parity data>,<Error correction level>
 <Mask number><Data input mode ("M")>,
 <Character mode1><Data character string1>,
 <Character mode2><Data character string2>,
 < : >< : >,
 <Character mode n><Data character string n>,[End code]

Bar code type: W1D (Data manual setting)

File format:

<Model selection method>
<Bound mode identifier ("D")><Code number>
<Number of divisions><Parity data>,
<Error correction level><Mask number>
<Data input mode("M")>,
<Character mode 1><Data character string1>,
<Character mode 2><Data character string2>,
< : >< : >,
<Character mode n><Data character string n>,
[End code]

Bar code type : W1d (Automatic data setting)

File format:

<Bound mode identifier ("D")><Code number>
<Number of divisions><Parity data>,
<Data character string> [End code]

The following data should be placed before standard mode file specification.

Bound mode identifier <D>

Code number <01 to 16>

Value indicating the position of code among number of divisions..

Number of divisions <01 to 16>

Value of number of divisions

Parity data<1 byte>

Value (bytes) of all print data (Print data before division) with EX-OR removed.

Error correction level, Mask number, Data input mode, Character mode and Data character string are the same as those of the normal mode.



Bar code W1C / W1c: Data Matrix

This is a two-dimensional bar code and variable in length.

Barcode font type

W1C :Data amount should be set by 4 -digit bytes

W1c :Data amount is automatically set.

Input data consists of the following six elements:

4-digit-- Amount of data to be used when W1C is Bytes following this value should be specified. (Including 10 bytes for ECC and ID and encode .) When W1c is specified, the field is blank.

3-digit-- Quality level(000,050,080,100,140,200)
“Quality” refers to the amount of data that is added to the symbol for error correction. The AIM specification refers to it as the ECC value.

1-digit-- Format identification(0,1,2,3,4,5,6)
0-Automatically choose the encodation scheme based on the characters to be encoded.
1-Numeric data.
2-Upper-case alphabetic.
3-Upper-case alphanumeric and punctuation characters(period, comma, hyphen, slash)
4-Upper-case alphanumeric.
5-ASCII,the full 128 ASCII character set.
6-Any 8-bit byte.
If an ECC 200 is specified, this value is not used.

3-digit-- Rows to encode
When ECC 000-140 is specified, the number of these values must be odd(9 - 49).
And, when ECC 200 is specified, the number of these values must be even(10, 12..., 26, 32, 36, 40, 44, 48, 52, 64, 72, 80, 88, 96, 104, 120, 132, 144).
Moreover, when this value is set as 000, rows is calculated automatically.
The symbol will be sized to a square if the rows and columns do not match.

3-digit-- Columns to encode
When ECC 000-140 is specified, the number of these values must be odd(9 - 49).
And, when ECC 200 is specified, the number of these values must be even(10, 12..., 26, 32, 36, 40, 44, 48, 52, 64, 72, 80, 88, 96, 104, 120, 132, 144).
Moreover, when this value is set as 000, columns is calculated automatically.
The symbol will be sized to a square if the rows and columns do not match.

Variable in length Data character string

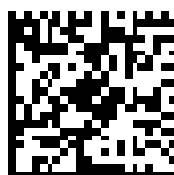

Bar code W1F / W1f: AZTEC

This is 2-dimensional and variable length bar code. Variable length bar codes can be generated by specifying their bar code type.

W1F :Data amount should be set by 4-digit bytes

W1f :Data amount is automatically set.

The input data is comprised of 5 elements.

- 4 digits-- Amount of data to be used when W1F is specified.
Bytes following this value should be specified.
(Including 4 bytes for ECI and EC setting.)
When W1f is specified, the field is blank.

- 1 digit-- ECI function
0:Invalid
1:Valid

- 3 digits-- EC setting
Error correction and specification of amount of printable data
(Setting range: 000 – 300)

Set value	Error correction ratio
000	: 23%
001 – 099	: % of specified value
100 – 104	:Compact 1 to 4 layers
201 – 232	:Full size 1 to 32 layers
300	:Decimal numbers 0 to 255 should be specified.

(AZTEC code of 1-byte data is generated.)

Variable length-- Data character string

In the case of W1F specification, the number of characters will be those obtained by subtracting the total of 4 bytes for ECI function and error correction designation from the number of bytes initially set.



Bar code ESC enhancing + M: Matrix 2 of 5

This is a bar code comprised of only numeric numbers and the number of digit has variable length. The standard ratio is 5:2. When using this bar code, the bar code type should be specified as [ESC] and add "M" at the head of the data part.



Chapter 3

Overlay Function

3.1 Outline	3-2
3.2 Type of Memory	3-2
3.3 Storage and Readout Commands	3-2
3.4 Type of Graphic Image Data	3-4
3.5 Font Downloading Commands	3-5

3.1 Outline

This printer once stores the required images, ruled lines and character strings in the on-board memory or optional memory module, then overlays the data onto the printing data.

3.2 Type of Memory

Memory assignment will be specified by each emulation as follows.

Allocation of module	Command Set		
	DMI / DMW	DM4 / DM8	DPP
on-board SD-RAM	D	A	B
on-board flash memory	G	B	A
PCMCIA Card (option)	E or F	E or F	E or F
Current memory module	on-board SD-RAM	on-board SD-RAM	on-board SD-RAM

Note: Factory Default (*) can be changed by the command. When a memory assignment parameter (n) that is not specified (N/A) in the above list is selected, the memory C is automatically selected.

3.3 Storage and Readout Commands

Two commands are available for storage and readout.

- 1 System level commands (occasional execution commands starting with 02H)

Graphic image writing commands for on-board RAM or on-board Flash RAM or IC card.

I (A/B/C) faa..a

- 2 Label format commands (occasional execution commands without control codes)

Graphic data reading commands for on-board RAM or on-board Flash RAM or IC card

1Yaa000aa..a

Commands for reading and writing printing data (such as ruled lines and character strings) in the on-board RAM or IC card

s(A/B/C) aa..a

raa..a

The user gives the required name to the data to be stored by using these commands and the data is read out with this name.

3.4 Type of Graphic Image Data

The data to be stored in the on-board memory or memory module with the command "l(A/B/C)faa..a" above are as follows:

- 1 7-bit image loading file data
Without header
Data in ASCII codes

- 2 8-bit image format data (image saved in reverse)
With header
Data in hex codes

- 3 8-bit image format data (image saved in normal)
With header
Data in hex codes

- 4 PCX format data (saved in normal)

- 5 PCX format data (saved in reverse)

- 6 BMP format data (saved in normal)

- 7 BMP format data (saved in reverse)

For details, refer to 4.6 Graphic Printing in Chapter 4 Printing Command Examples.

3.5 Font Downloading Commands

Font downloading commands are used to transmit the user-specified font (bit map font) to the on-board memory or memory module. The transmission of the downloading font data is in conformity with the HP standard ESC sequence.

Command	Function
ESC*c###D	Font ID specification ### = ID number specified with 3 digits 000 - 099: reserved with on-board fonts 100 - 999: specified among these numbers
ESC)s#Wnn..n	Font structure specification # = number of data following this indicated nn...n: font structure data (font header definition)
ESC*c#E	Character code specification # = ASCII character number specified
ESC(s#Wnn...n	Downloading font data # = number of data following this indicated nn...n: actual bit map data

Chapter 4

Printing Command Examples

4.1 Printing Position Specification	4-2
4.2 Character Printing	4-3
4.3 Ruled Line Printing	4-4
4.4 Bar Code Printing	4-5
4.5 Increasing and Decreasing Number Printing	4-7
4.6 Sample Printing	4-9

This chapter describes the procedure for program preparation and actual program examples for printing data.

4.1 Printing Position Specification

The origin for positioning bar codes or characters to be printed on labels is at the bottom left of label, and with the distance from that point, the printing position is designated.

The distance upward from the point is called the row address, while the distance rightward from the point is called the column address. Units of 0.01 inch or 0.1 mm are used. Changing units is provided with the m command. In this explanation, the address is specified in 0.1 mm units.

Relevant command: m

After receiving this command, all length specification commands are in 0.1 mm units.

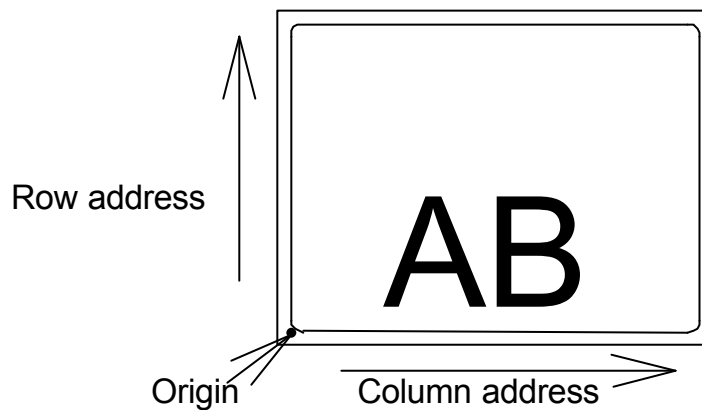

The origin for row address is 2 mm from the top of the paper.

Note: Data in [] is hex.

4.2 Character Printing

When characters or strings are to be printed, attribute data such as printing direction and printing position must be added to the top of the strings. With the program example printing "AB" on the previous page, the contents of the character printing are described below.

Program example

[02] m	Sets units to metric system
[02] L	Starts label format mode
D11	Sets pixel size
361100004000800AB	Character data
E	Ends label format mode and prints

3 6 1 1 000 0400 0800 AB

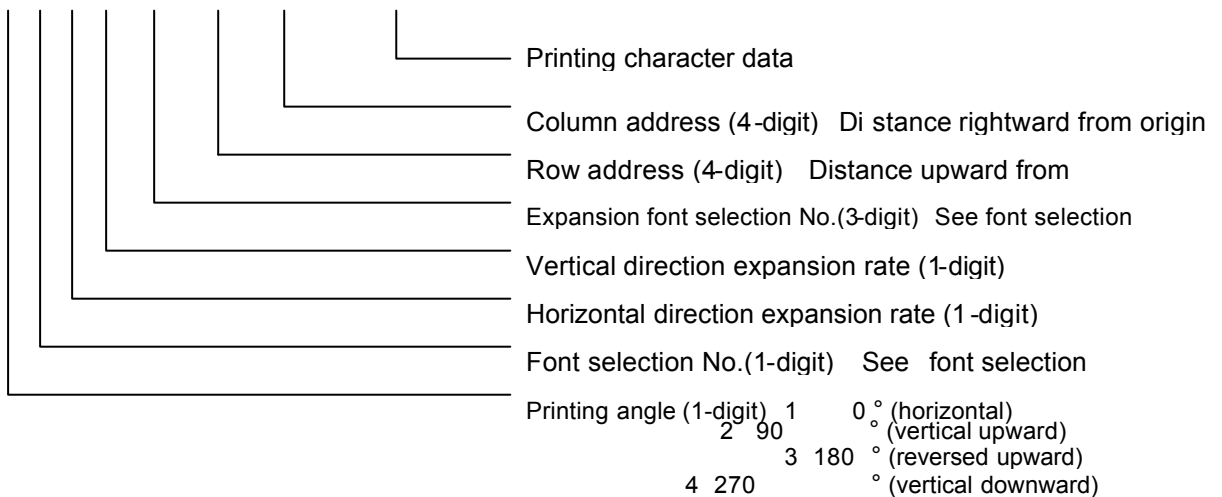

Font selection (ANK/alphabet):

To select the font, specify a font selection number from 1 to 8 or 9. When font number 9 is selected, the expansion font is selected according to the contents of the expansion font selection number.

391100504000800AB

4.3 Ruled Line Printing

When ruled lines are to be printed, attribute data such as printing position and line types must be included in the command.

Ruled line drawing command: Lhhhvvv, lhhhhvvvv

L, l: Specifies line drawing L sets 3-column width and l sets 4-column width

hhh, hhhh: Specifies width of line in horizontal direction

vvv, vvvv: Specifies width of line in vertical direction

Square drawing command: Bhhhvbbbsss, bhhhhvvvvbbbssss

B, b: Specifies box drawing B sets 3-column width and height and

b sets 4-column width and height

hhh, hhhh: Specifies width of box in horizontal direction

vvv, vvvv: Specifies width of box in vertical direction

bbb, bbbb: Specifies width of line in horizontal direction

sss, ssss: Specifies width of line in vertical direction

Program examples

1X1100004500500L450010	Thick ruled line in horizontal direction
1X1100005000950L005400	Ruled line in vertical direction
1X1100005000500B400400005005	Box printing

Print sample

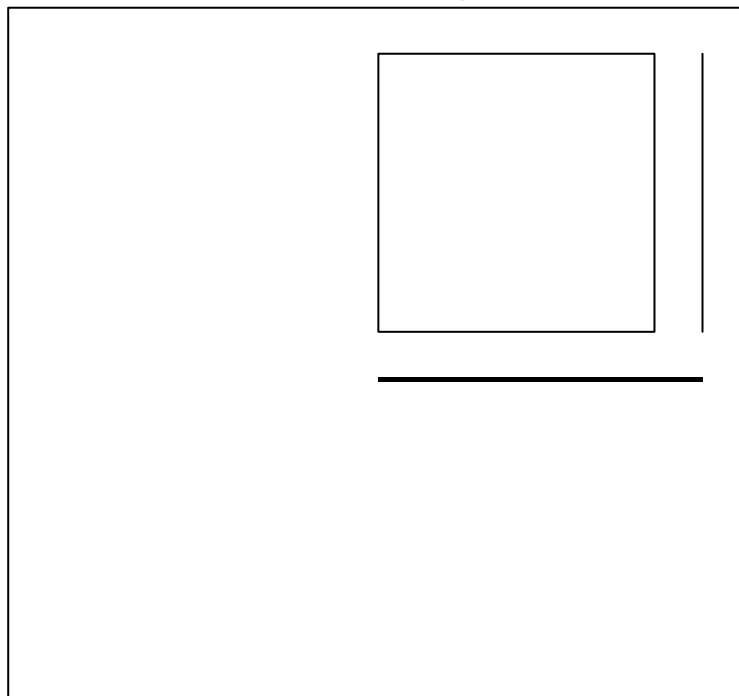

4.4 Bar Code Printing

When bar codes are to be printed, attribute data such as printing position and bar code types must be included in the command.

Program description

3 A 6 2 090 0200 0700 BARCODE

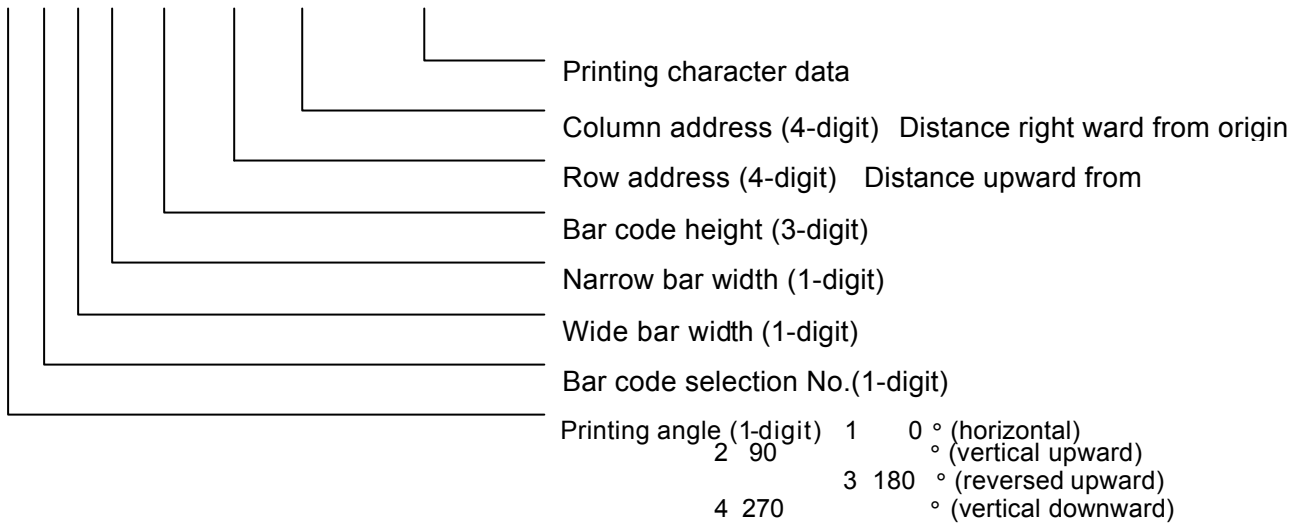

Bar code selection number

Number	Bar code name
A	Code 3 of 9
D	Interleaved 2 of 5
H	HIBC
I	CODABAR
J	Interleaved 2 of 5 W/BARS
K	PLESSEY
L	CASE CODE
B	UPC-A
C	UPC-E
E	CODE 128 (B)
F	EAN-13
G	EAN-8
M	UPC 2DIG ADD
N	UPC 5 DIG ADD
O	Code 93
p	ZIP
Q	UCC/EAN 128
R	UCC/EAN 128 (for K-MART)
S	UCC/EAN/128 Random Weight
T	Telepen
U / u	UPS MaxiCode
v	FIM
Z / z	PDF417
W1C / W1c	DataMatrix
W1D / W1d	QR CODE
W1F / W1f	AZTEC
ESC extension +q	QR CODE
ESC extension +M	Matrix 2 of 5

4.5 Increasing and Decreasing Number Printing

When continuously increasing and decreasing numbers like serial numbers are to be printed on labels, continuous printing can be performed automatically by the counter in the printer. At this time, the number of steps for increasing and decreasing (addition and subtraction width) and number of prints of the same label can be set.

Command outline is as follows:

+pii : ii decimal ii value is added
- pii : ii decimal ii value is subtracted
>pii : ii base 36 system ii value from 0 to Z is added
<pii : ii base 36 system ii value from 0 to Z is subtracted

Note: p value is zero-fill character

^nn : Prints same number nn times and advances to the next counter

Example 1: One addition (Fig. 1)

[02] m
[02] L
D22
331100003000800100
+01
Q0004
E

Example 2: Two subtractions (Fig. 2)

[02] m
[02] L
D22
331100003000800100
- 2
Q0004
E

Example 3: Three additions
and two prints (Fig. 3)

[02] m
[02] L
D22
331100003000800100
+03
^02
Q0004
E

Example 4: Five additions and
base 36 system (Fig. 4)

[02] m
[02] L
D22
331100003000800100
>05
Q0004
E

100
101
102
103

Fig.1

100
98
96
94

Fig.2

100
100
103
103

Fig.3

100
105
10A
10F

Fig.4

4.6 Sample Printing

The print sample and printing data combining the commands above are as follows:

[02] m	Sets units to metric system
[02] M1500	Max. label length
[02] L	Starts label format mode
PK	Printing speed
SO	Paper feed speed
D11	Sets pixel size
C0000	Offset in direction of column (vertical)
R0000	Offset in direction of row (horizontal)
H10	Printing density (amount of thermal transfer)
1X11000005000050B950900010010	Specifies box field
1X1100008500060L930005	Specifies ruled line field 1
1X1100008550750L005085	Specifies ruled line field 2
1X1100005000060L930005	Specifies ruled line field 3
3a931000800085001234567890123	Specifies bar code field
321100006000930SERIAL	Specifies character field
321100006500880(SN)	Specifies character field
35110000650070001234567890123	Specifies character field
1Y1100001200060eagle	Specifies graphics field
E	Ends label format mode and prints

(Note: Data in [] is hex.)

Print sample



Chapter 5

Interface Functions

5.1	RS-232C Serial Interface	5-2
5.2	Parallel Interface	5-6

5.1 RS-232C Serial Interface

1 Specifications

Transmission system: Asynchronous communication method (full duplex)

Signal logic level: RS-232C

Baud rate: 2400, 4800, 9600, 14400, 19200,
38400, 57600, 115200 bps

Data length: 7 bits or 8 bits

Start bit: 1 bit

Stop bit: 1bit, 2bits

Parity check: Odd parity, even parity, none

Connector: D-sub 25pin 17LE -13250-27(D41)(DDK) or
equivalent

2 Example of connection of computer and printer

IBM compatible machines

Communication control: XON/XOFF or CTS/DTR

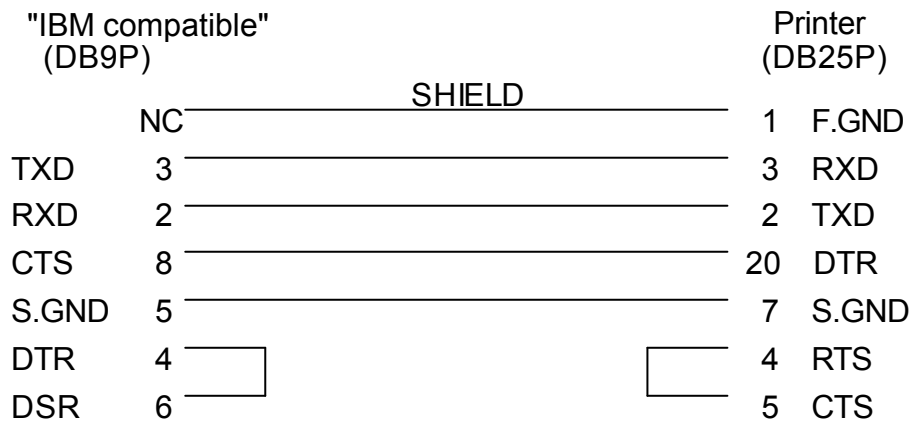

2 XON/XOFF protocol

(a) Conditions for sending XON

- Communication is enabled after power is turned ON.
- Residual capacity of the buffer is 1 K bytes or more after sending XOFF code.
- XOFF code is output due to error and printer returns to normal conditions.

(b) Conditions for sending XOFF

- Printer is in error.
- Printer is in pause state.
- Received buffer has less than 128 bytes available.

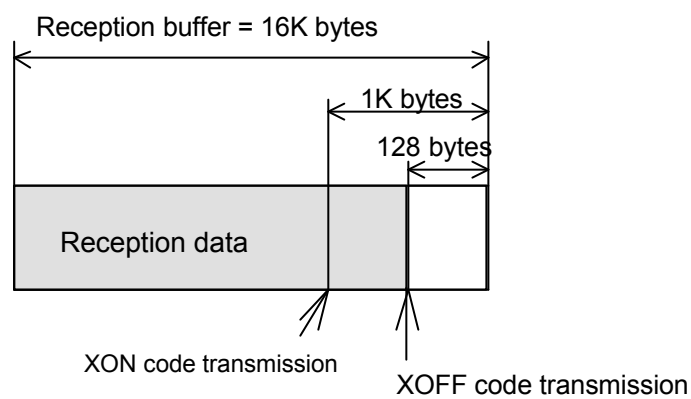

(c) Communication control flowchart

The following is a reference flowchart for sending and receiving data by using printer transmission request command (01+A, or 01+F). (In XON/XOFF protocol and compatible machine ON mode)

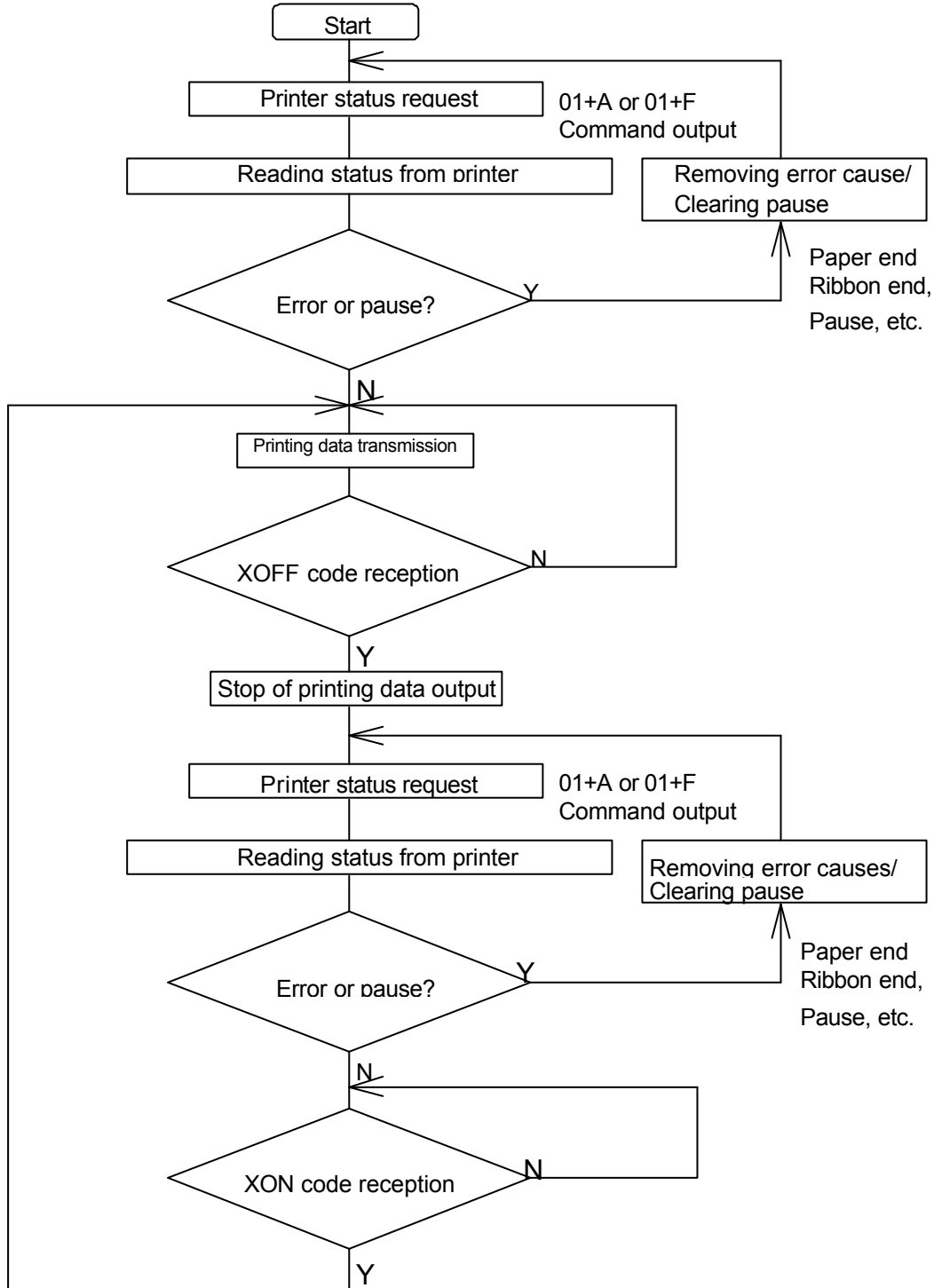

3 DTR protocol

(a) Conditions for making DTR signal Ready (High)

The following must be required:

- Printer is on line.
- Receive buffer has more than 1K bytes available.

Note: When receive buffer has less than 128 bytes available, DTR signal becomes “Busy (Low)” level and this “Busy (Low)” level is kept until receive buffer has at least 1 K bytes available.

(b) Conditions for making DTR signal BUSY (Low)

- Printer is in error.
- Receive buffer has less than 128 bytes available.

5.2 Parallel Interface

1 Specifications

Transmission system: 8 bits parallel (compatibility mode)

Synchronization: Strobe pulse

Handshake: ACKNLG and BUSY

Signal logic level: TTL

2 Usable interface connector

Printer side: 36-pin amphenol type

A standard parallel interface should be used. (The shortest distance should be used for the interface cable.)

3 Connector signal arrangement

Pin No.	Signal name	Input/Output	Function
1	STROBE	Input	Strobe signal to read 8-bit data
2-9	DATA1-8	Input	8-bit parallel signal
10	ACKNLG	Output	8-bit data request signal
11	BUSY	Output	Signal to indicate printer BUSY status
12	PERROR	Output	Signal to indicate paper out
13	SELECT	Output	Signal to indicate whether printer is on-line or off-line
14	$\overline{\text{AUTOFD}}$	Input	Not used
15	NC	-	Not used
16	GND	-	Ground
17	FGND	-	Frame ground
18	P.L.H.	Output	Not used
19-30	GND	-	Ground
31	$\overline{\text{INIT}}$	Input	Invalid (ignored)
32	FAULT	Output	Signal to indicate printer error
33-35	NC	-	Not used
36	$\overline{\text{SELECTIN}}$	Input	Note used

4 Timing chart

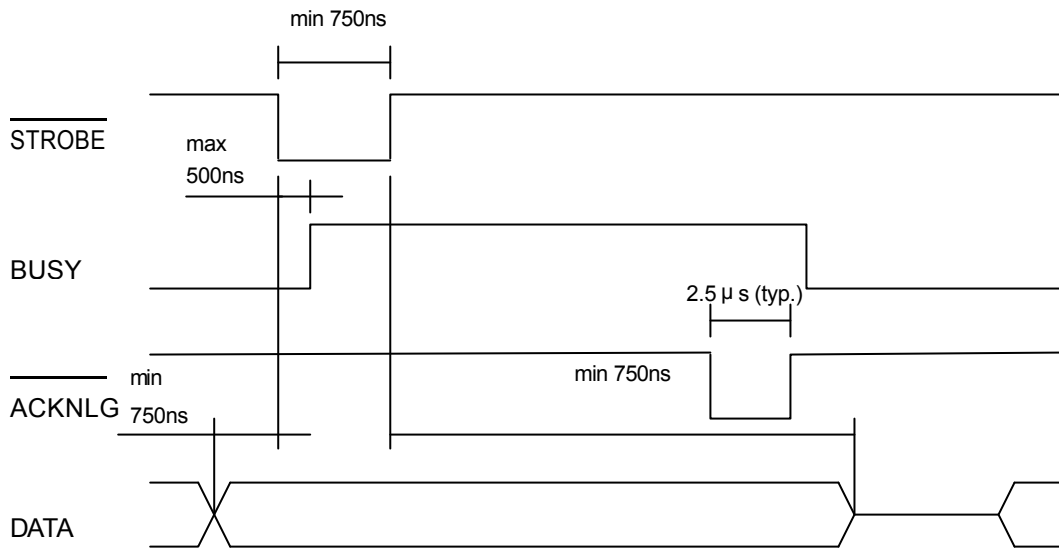

ACKNLG "LOW" indicates that the printer has received data.

The BUSY "HIGH" indicates that the printer is not able to receive data and the "LOW" indicates that the printer is able to receive data.

Appendixes

A.1	List of Commands	A-2
A.2	List of Font Character codes	A-8
A.3	Printing Edit Function	A-10
A.4	Specification of Switching of Control codes	A-14
A.5	Specification List of Command sets	A-15
A.6	List of Specifications by Model	A-16

Appendix 1 List of Commands

Y : Supported command

N/A: Not supported command

System level commands			Models	
			521 621	9001 9301 8301
SOH	#	Reset	Y	Y
	A	Printer status transmission request (8 bytes)	Y	Y
	B	Pause	Y	Y
	C	Stop/cancel	Y	Y
	D	Stop immediate execution of system level commands	Y	Y
	E	Transmission of number of remaining prints	Y	Y
	F	Printer status transmission request [1 byte]	Y	Y
	l	Error status transmission request [4-byte]	Y	Y
STX	A	Setting date and time [transmission]	N/A	Y
	a	Feedback character transmission validness	Y	Y
	B	Date and time transmission request	N/A	Y
	cnnnn	Setting continuous paper length	Y	Y
	d	Setting 2-page edit mode (double buffer)	Y	Y
	Ennnn	Setting number of printing sheets for edited format	Y	Y
	e	Selecting edge sensor for paper position detection	Y	Y
	F	Label one sheet feed	Y	Y
	fnnn	Setting paper position setting when cutting and peeling	Y	Y
	G	Printing edited format	Y	Y
	lmfaa	Writing graphic data	Y	Y
	imTnn	TrueType fonts downloading command	Y	Y
	J	Setting pause per each label printing	Y	Y
	KDabc	printer settings	Y	N/A
	Kfnnnn	Setting paper position setting when cutting and peeling	Y	Y
	k	"Y" code transmission request	Y	Y
	L	Starting printing contents setting (label format)	Y	Y

(continued)

(continued)

System level commands			Models	
			521 621	9001 9301 8301
STX	Mnnnn	Setting max. label length (detection miss checking)	Y	Y
	m	Changing units from inch system to metric system	Y	Y
	n	Changing units from metric system to inch system	Y	Y
	Onnnn	Setting printing position (form offset)	Y	Y
	o	Paper cut	Y	Y
	P	Setting dump mode on	Y	Y
	p	Pause in occasional execution	Y	Y
	Q	Clearing all memory modules	Y	Y
	q	Clearing memory module contents q (A/B)	Y	Y
	r	Selecting reflective (black line) sensor for paper position detection	Y	Y
	Sa	Setting paper feed speed	Y	Y
	s	Setting one page edit mode (single buffer)	Y	Y
	T	Printing quality test pattern	Y	Y
	Unnaa	Rewriting specified format register contents	Y	Y
	V	Setting memory switch contents	Y	Y
	v	Version number transmission request	Y	Y
	W	Information-in-memory-module transmission request	Y	Y
	w	Testing flash memory	Y	N/A
	Xa	Selecting default module (A/B)	Y	Y
	xntname	Clearing memory module contents (in file units)	Y	Y
	Y	Sensor level issued to port	N/A	N/A
	yS	TrueType fonts Symbol Set Selection	Y	Y
	Z	Test print for printer status	Y	Y
	z	Packing memory module contents	N/A	N/A
	"ESC"+G	Select Command Set	Y	Y
	"ESC"+M	Setting Printing Method	Y	N/A
	"ESC"+S	Paper detection sensor voltage transmission request	N/A	N/A
	"ESC"+T	Head disconnection detection	Y	Y
"ESC"+t	Setting ejection (tear-off)	Y	Y	
"ESC"+wnnnn	Setting label width	Y	Y	

Commands after the print contents definition mode is turned on with "STX" + "L"			Models	
			521 621	9001 9301 8301
None	An	Set format attribute	Y	Y
	"ESC"+Bn	Specifying development method	Y	Y
	Cnnnn	Setting column offset	Y	Y
	cnn	Setting number of cuts (2-digit)	Y	Y
	Dhv	Setting horizontal and vertical pixel sizes	Y	Y
	E	Completion of setting printing contents and printing labels	Y	Y
	G	Entering previous character column into global register	Y	Y
	Hnn	Setting print density (heat factor)	Y	Y
	m	Changing units from inch system to metric system	Y	Y
	n	Changing units from metric system to inch system	Y	Y
	Pa	Setting printing speed (printable area)	Y	Y
	pa	Setting backfeed speed	Y	Y
	"ESC"+Pnn	Specifying space between characters	Y	Y
	Qnnnn	Setting number of prints	Y	Y
	Rnnnn	Setting row offset	Y	Y
	r aa..	Calling label format	Y	Y
	S a	Specifying paper feed speed	Y	Y
	s	Label format storage s (A/B)aa..a	Y	Y
	Tnn	Specifying ending code	Y	Y
	U	Setting previous field to character -string-replacement -mode field	Y	Y
	X	Completion of setting printing contents (field preparation)	Y	Y
	ySxx	TrueType font symbol setting	Y	Y
	+ pii	Specifying previous data increment	Y	Y
	- pii	Specifying previous data decrement	Y	Y
	> pii	Specifying previous data increment (0-9, A-Z)	Y	Y
	< pii	Specifying previous data decrement (0-9, A-Z)	Y	Y
	^ nn	Specifying number of label prints for same contents	Y	Y
	: nnnn	Specifying number of cuts (4-digit)	Y	Y
	z	Using slash zero	Y	Y
	1	Rotation angle: 0 degree	Y	Y
2	Rotation angle: 90 degrees			
3	Rotation angle: 180 degrees			
4	Rotation angle: 270 degrees			
	Definition of character strings, bar codes, ruled lines and graphics. (Each data is a defined form structure including position and other information)			

Font downloading commands			Models	
			521 621	9001 9301 8301
ESC	*C###D	ID assignment	Y	Y
)S#Wnn..n	Descriptor writing	Y	Y
	*C#E	Character code writing	Y	Y
	(S#Wnn..n	Character data downloading	Y	Y

Font setting field (after the print contents definition mode is turned on with "STX" + "L")			Models		
2nd digit	5th, 6th, 7th digit	Specified font	521 621	9001	9301 8301
0	000	System font 0	Y	Y	Y
1	000	System font 1	Y	Y	Y
2	000	System font 2	Y	Y	Y
3	000	System font 3	Y	Y	Y
4	000	System font 4	Y	Y	Y
5	000	System font 5	Y	Y	Y
6	000	System font 6	Y	Y	Y
7	000	System font 7 (OCR-A)	Y	Y	Y
8	000	System font 8 (OCR-B)	Y	Y	Y
9	A04	Smooth font (CG Triumvirate) 4 pt	N/A	N/A	Y
	A05	Smooth font (CG Triumvirate) 5 pt	N/A	N/A	Y
	A06, 001	Smooth font (CG Triumvirate) 6 pt	Y	Y	Y
	A08, 002	Smooth font (CG Triumvirate) 8 pt	Y	Y	Y
	A10, 003	Smooth font (CG Triumvirate) 10 pt	Y	Y	Y
	A12, 004	Smooth font (CG Triumvirate) 12 pt	Y	Y	Y
	A14, 005	Smooth font (CG Triumvirate) 14 pt	Y	Y	Y
	A18, 006	Smooth font (CG Triumvirate) 18 pt	Y	Y	Y
	A24, 007	Smooth font (CG Triumvirate) 24 pt	Y	Y	Y
	A30, 008	Smooth font (CG Triumvirate) 30 pt	Y	Y	Y
	A36, 009	Smooth font (CG Triumvirate) 36 pt	Y	Y	Y
	A48, 010	Smooth font (CG Triumvirate) 48 pt	Y	Y	Y
	A72	Smooth font (CG Triumvirate) 72 pt	Y	Y	Y
	C04	Smooth font (CG Triumvirate Bold) 4 pt	N/A	N/A	Y
	C05	Smooth font (CG Triumvirate Bold) 5 pt	N/A	N/A	Y
	C06, 121	Smooth font (CG Triumvirate Bold) 6 pt	Y	Y	Y
	C08, 122	Smooth font (CG Triumvirate Bold) 8 pt	Y	Y	Y
	C10, 123	Smooth font (CG Triumvirate Bold) 10 pt	Y	Y	Y
	C12, 124	Smooth font (CG Triumvirate Bold) 12 pt	Y	Y	Y
	C14, 125	Smooth font (CG Triumvirate Bold) 14 pt	Y	Y	Y
	C18, 126	Smooth font (CG Triumvirate Bold) 18 pt	Y	Y	Y
C24, 127	Smooth font (CG Triumvirate Bold) 24 pt	Y	Y	Y	
C30, 128	Smooth font (CG Triumvirate Bold) 30 pt	Y	Y	Y	
C36, 129	Smooth font (CG Triumvirate Bold) 36 pt	Y	Y	Y	
C48, 130	Smooth font (CG Triumvirate Bold) 48 pt	Y	Y	Y	
C72	Smooth font (CG Triumvirate Bold) 72 pt	Y	Y	Y	

Bar code setting field (after the print contents definition mode is turned on with "STX" + "L")		Models	
2nd digit	Specified bar code (upper-case characters: visible code, lower -case characters: non-visible code)	521 621	9001 9301 8301
A	Code 3 of 9	Y	Y
B	UPC-A	Y	Y
C	UPC-E	Y	Y
D	Interleaved 2 of 5	Y	Y
E	Code 128	Y	Y
F	EAN-13 (JAN-13)	Y	Y
G	EAN-8 (JAN-8)	Y	Y
H	HIBC (Modulus 43 -used Code 3 of 9)	Y	Y
I	CODERBAR (NW-7)	Y	Y
J	Int 2 of 5 (Modulus 10 -used Interleaved 2 of 5)	Y	Y
K	Plessey	Y	Y
L	CASE CODE	Y	Y
M	UPC 2DIG ADD (UPC 2 -digit supplementary code)	Y	Y
N	UPC 5DIG ADD (UPC 5 -digit supplementary code)	Y	Y
O	Code 93	Y	Y
P	ZIP	Y	Y
Q	UCC/EAN128	Y	Y
R	UCC/EAN128 (for K-MART)	Y	Y
S	UCC/EAN128 Random Weight	Y	Y
T	Telepen	Y	Y
U / u	UPS MaxiCode	Y	Y
V	FIM	Y	Y
W1C/W1c	DataMatrix	Y	Y
W1D/W1d	QR Code	Y	Y
W1F/W1f	AZTEC	N/A	N/A
"ESC"+q	QR CODE	Y	Y
"ESC"+M	Matrix 2 of 5	Y	Y
X	Lines and Boxes	Y	Y
Y	Graphic data readout specifying command	Y	Y
Z / z	PDF-417	Y	Y
STX+Sa	Reading printing contents from global register	Y	Y
STX+T	Printing date and time	Y	Y

Appendix 2 List of Font Character Codes

1 System font 1 – 6

L \ H	Binary	0000	0001	0010	0011	0100	0101	0110	0111	1000	1001	1010	1011	1100	1101	1110	1111
Binary	Hex	0	1	2	3	4	5	6	7	8	9	A	B	C	D	E	F
0000	0			(SP)	0	@	P	`	p	Ç	É	á					
0001	1			!	1	A	Q	a	q	Ü	æ	í				β	
0010	2			"	2	B	R	b	r	é	Æ	ó					
0011	3			#	3	C	S	c	s	â	ô	ú					
0100	4			\$	4	D	T	d	t	ä	ö	ñ					
0101	5			%	5	E	U	e	u	à	ò	Ñ					
0110	6			&	6	F	V	f	v	â	û	ª					
0111	7			'	7	G	W	g	w	ç	ù	º					
1000	8			(8	H	X	h	x	ê	ÿ	¿					
1001	9)	9	I	Y	i	y	ë	ö	®					
1010	A			*	:	J	Z	j	z	è	Ü	¬					
1011	B			+	;	K	[k	{	ï	ø	½					
1100	C			,	<	L	\	l		î	£	¼					
1101	D			-	=	M]	m	}	ì	Ø	¡	¢				
1110	E			.	>	N	^	n	~	Å	x	<<	¥				
1111	F			/	?	O	_	o	¸	À	f	>>					€

2 System font 7 (OCR-A)

L \ H	Binary	0000	0001	0010	0011	0100	0101	0110	0111	1000	1001	1010	1011	1100	1101	1110	1111
Binary	Hex	0	1	2	3	4	5	6	7	8	9	A	B	C	D	E	F
0000	0			(SP)	0	à	P	`	p								
0001	1			!	1	A	Q	a	q								
0010	2			"	2	B	R	b	r								
0011	3			#	3	C	S	c	s								
0100	4			\$	4	D	T	d	t								
0101	5			%	5	E	U	e	u								
0110	6			&	6	F	V	f	v								
0111	7			'	7	G	W	g	w								
1000	8			(8	H	X	h	x								
1001	9)	9	I	Y	i	y								
1010	A			*	:	J	Z	j	z								
1011	B			+	;	K	[k	{								
1100	C			,	<	L	\	l									
1101	D			-	=	M]	m	}								
1110	E			.	>	N	^	n									
1111	F			/	?	O	_	o									

3 System font 8 (OCR-B)

L \ H	Binary	0000	0001	0010	0011	0100	0101	0110	0111	1000	1001	1010	1011	1100	1101	1110	1111
Binary	Hex	0	1	2	3	4	5	6	7	8	9	A	B	C	D	E	F
0000	0			(SP)	0	@	P	`	p								
0001	1			!	1	A	Q	a	q								
0010	2			"	2	B	R	b	r								
0011	3			#	3	C	S	c	s								
0100	4			\$	4	D	T	d	t								
0101	5			%	5	E	U	e	u								
0110	6			&	6	F	V	f	v								
0111	7			'	7	G	W	g	w								
1000	8			(8	H	X	h	x								
1001	9)	9	I	Y	i	y								
1010	A			*	:	J	Z	j	z								
1011	B			+	;	K	[k	{								
1100	C			/	<	L	\	l									
1101	D			-	=	M]	m	}								
1110	E			.	>	N	^	n									
1111	F			/	?	O	_	o									

4 Expansion font (CG Triumvirate, CG Triumvirate Bold Smooth font)

L \ H	Binary	0000	0001	0010	0011	0100	0101	0110	0111	1000	1001	1010	1011	1100	1101	1110	1111
Binary	Hex	0	1	2	3	4	5	6	7	8	9	A	B	C	D	E	F
0000	0			(SP)	0	@	P	'	p	Ç	É	á			ö	Ó	
0001	1			!	1	A	Q	a	q	ü	æ	í			Ð	ß	±
0010	2			"	2	B	R	b	r	é	Æ	ó			Ê	Ô	
0011	3			#	3	C	S	c	s	â	ô	ú			Ë	Ò	¾
0100	4			\$	4	D	T	d	t	ä	ö	ñ			È	õ	
0101	5			%	5	E	U	e	u	à	ò	Ñ	Á		ı	Õ	
0110	6			&	6	F	V	f	v	å	û	ª	Â	ã	í	µ	÷
0111	7			'	7	G	W	g	w	ç	ù	º	À	Ã	î	þ	·
1000	8			(8	H	X	h	x	ê	ÿ	¿	©		ï	ƒ	°
1001	9)	9	I	Y	i	y	ë	Ö	®				Ú	¨
1010	A			*	:	J	Z	j	z	è	Ü					Û	·
1011	B			+	;	K	[k	{	ï	ø	½				Ù	
1100	C			,	<	L	\	l		î	£	¼				ý	
1101	D			-	=	M]	m	}	ì	Ø	¡	¢			Ý	
1110	E			.	>	N	^	n	~	Ä	×		¥		ì		
1111	F			/	?	O		o		Å	f						€

Appendix 3 Printing Edit Function

- 1 Unnaa.. : particular printing contents are changed

(see sample No. 1)

Printing contents are stored in the field register in order from number 1. The Unnaa.. command replaces the data of "nn" in the field register with "aa.." The transmission data is applied for the changing part and the bit map is regenerated only for the changing part so printing speed is high.

- 2 s, r : label format storage and readout

(see sample No. 2)

Fixed-form printing contents are stored in the memory card. When printing, the fixed-form printing contents are read out from the memory card, and printing contents can be added, so fixed-form printing contents do not need to be transmitted each time they are requested.

- 3 +pi., >pi. : incrementing and decrementing specified

Any printing contents can be specified. The bit map is generated only for the specified part so printing speed is high.

- 4 G, Sa : printing string storage and readout

(see sample No. 3)

Strings are stored in or read out from the global register. It is useful for printing string contents to be printed on the bar code. When changing printing contents, it is enough to give one place correction.

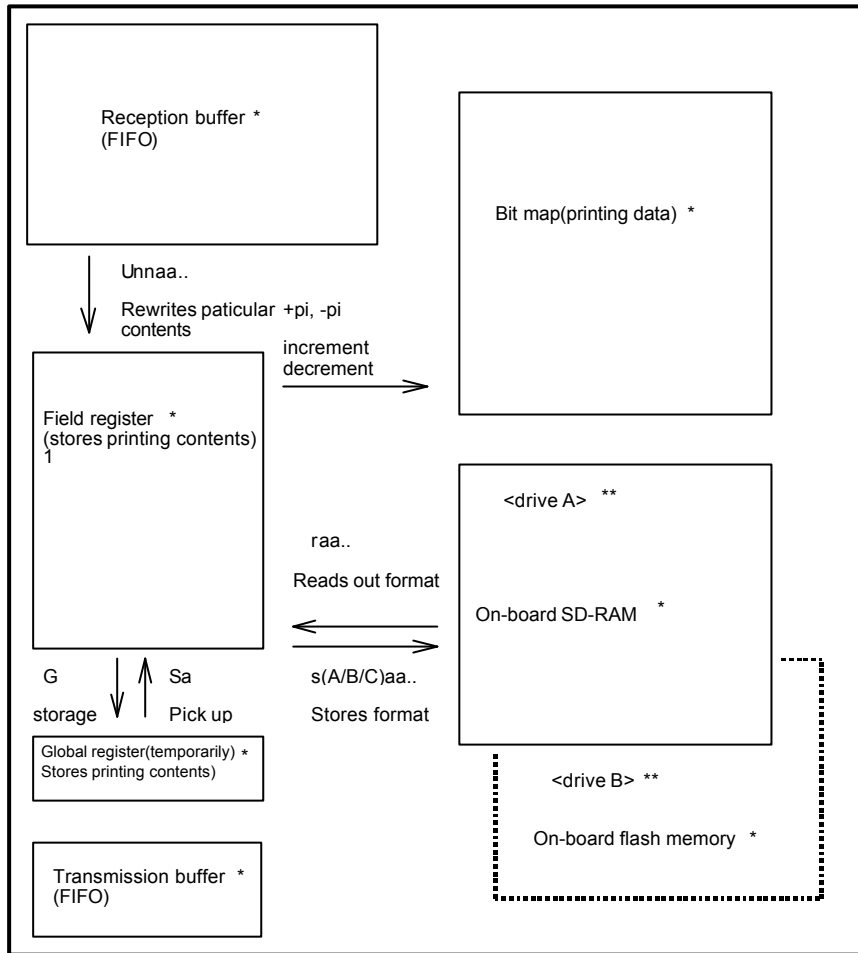

* Area sizes such as each buffer and register vary by model.

For details, refer to “Appendix 6: List of Specifications by Model”.

**This module allocation is for DM4/DM8.

Module allocations vary depending on the command set.

Sample No. 1

"Unnaa.." command: S pecified register contents rewriting

[02] m	Sets units to mm
[02] L	Starts label format
D11	
161200000000050FIX	"FIX" defined to field No 01
1611000000002500001	"0001" defined to field No 02
161100000800250ABCDEF	"ABCDEF" defined to field No 03
E	Ends label format and prints
[02] U020002	Changes 2nd field contents (agrees with number of characters)
[02] U03GHIJKL	Changes 3rd field contents (agrees with number of characters)
[02] G	Prints edited format
[02] U020003	Changes 2nd field contents (agrees with number of characters)
[02] U03MNOPQR	Changes 3rd field contents (agrees with number of characters)
[02] G	Prints edited format

Sample No. 2

"S (A/B/C) aa.." command: Storage of format to memory card

[02] m	Sets units to mm
[02] L	Starts label format
D11	
161200000000050FIX	"FIX" defined to field No 01
sDfdata	Stores file name "fdata" in RAM and ends label format
[02] L	Starts label format
rfdata	Reads out file name "fdata"
D11	
1611000000002500001	"0001" defined to field No 02
161100000800250LABEL1	"LABEL1" defined to field No 03
E	Ends label format and prints
[02] L	Starts label format
rfdata	Reads out file name "fdata"
D11	

1611000000002500002	"0002" defined to field No 02
161100000800250LABEL2	"LABEL2" defined to field No 03
E	Ends label format and prints
[02] L	Starts label format
rdata	Reads out file name "fdata"
D11	
1611000000002500003	"0003" defined to field No 02
161100000800250LABEL3	"LABEL3" defined to field No 03
E	Ends label format and prints

Sample No. 3

"G, S" command: Storage and read out of printing contents to global register

[02] m	Sets units to mm
[02] L	Starts label format
D11	
1611000000000500001	"0001" defined to field No 01
G	Stored in global register No A
161100000800050LABEL	"LABEL" defined to field No 02
G	Stored in global register No B
1A6207000000500[02]SA	Read out from global register No A
1A6207001000500[02]SB	Read out from global register No B
E	Ends label format and prints

Appendix 4 Specification of Switching of Control Codes

Control codes can be switched from the menu on the operation panel. By setting to ALT mode, the system level command start code SOH (Immediate execution command) and STX (Sequential execution command) will be changed to the commands in the table below.

When setting ALT mode, replace the standard codes in the table below of this command reference with the corresponding codes in ALT mode.

	STD mode (Initial setting)	ALT mode
Immediate execution command starting code in the system level	0x01(SOH)	0x5E(^)
Sequential execution command starting code in the system level	0x02(STX)	0x7E(~)
Label format command for specifying number of the same labels printed	0x5E(^)	0x40(@)*

* Crossovers immediate execution command starting code.

Appendix 5 Specification list of Command set

Table below are items whose specifications will be changed using the switching function of the emulation command sets.

Related commands	Item		Command sets		
			DMI/DMW	DM4/DM8	DPP
STX O	Reference values for printing starting position		0220 (2.20inches)	0220 (2.20inches)	0110 (1.10inches)
STX f STX Kf	Reference value for optional positions	Normal printing	000 (0.00inches)	220 (2.20inches)	110 (1.10inches)
		Cutter	100 (1.00inch)	340 (3.40inches)	230 (2.30inches)
		Peeling	050 (0.50inches)	270 (2.70inches)	146 (1.46inches)
		Tear off	070 (0.70inches)	290 (2.90inches)	166 (1.66inches)
STX I STX i STX q STX X STX x s	Specified destinations of memory modules	on-board SD-RAM	D	A	B
		on-board flash memory	G	B	A
		PC card	E or F	E or F	E or F
	Allocation of default module C		on-board SD-RAM	on-board SD-RAM	on-board SD-RAM
s	Specified locations of label format storage commands		Specify to place at the end of the label format. (End command "E" can be omitted.)	Specify to place at the end of the label format. (End command "E" can be omitted.)	Specify to place at any given location within the label format. (End command "E" or "X" is needed.)
D	Pixel size initial value		11 (Horizontal/Vertical 1 dot)	22 (Horizontal/Vertical 2 dots)	11 (Horizontal/Vertical 1 dot)
H	Setting range of printing density		0 to 30 (Initial value 10)	0 to 30 (Initial value 10)	0 to 20 (Initial value 10)

Appendix 6 List of Specifications by Model

Table below are specifications required when editing printing for each model such as memory size and the maximum page length.

Items	Model names			
	CL-S621 CL-S521	CL-S700 Series	CLP-9000	CLP-8301
on-board SD-RAM [Byte]	1024K	1024K	512K	512K
on-board flash memory [Byte]	1024K	1024K	512K	512K
Maximum page length	32inches	40inches	40inches	40inches
Number of maximum print fields	400	400	400	400
Field register data area [Byte]	20K	20K	20K	20K
Bit map area [Byte]	1892K	1660K	1922K	4652K
Reception buffer area [Byte]	16K	16K	16K	16K
Command buffer [Byte]	128K	128K	128K	128K
Paper setting	Left end reference			Centering
RTC	Uninstalled	With optional settings With standard equipment models		